



MASTERS
S
2670E

 **SPORTSMAN**
BOATS

*Owner's Manual and
Quick-Reference Guide*



WELCOME TO THE SPORTSMAN TEAM!

Here at Sportsman Boats, we take great pride in producing the finest, most well-designed saltwater fishing and pleasure boats on the market today. Our designs incorporate the most modern technology while applying good old “Common Sense” technology as well. From our advanced composite construction, ergonomic console designs, patented “Total Access” hatch, and superior ride and handling characteristics, we think you will agree that Sportsman is setting a new standard. Sportsman Boats builds the fastest growing line of family-friendly center console boats in-class, built with the latest designs, procedures and materials to give you and your family unparalleled performance with a dry, safe and comfortable ride.

We do not take lightly the confidence you have placed in us with your decision to purchase your Sportsman boat. We will always strive to provide for you and your family the superior customer service you deserve. We hope that you enjoy your time out on the water as much as we enjoy building your Sportsman boat!

Safe Boating and Tight Lines,
Tommy Hancock

IMPORTANT INFORMATION



BOAT INFORMATION / SPECIFICATIONS	
MODEL:	HULL SERIAL #:
PURCHASE DATE:	DELIVERED:
IGNITION KEY #:	REGISTRATION #:
DRAFT:	WEIGHT:
VERTICAL CLEARANCE:	
ENGINE / PROPELLER INFORMATION	
ENGINE MAKE:	MODEL:
ENGINE SERIAL #:	
PROPELLER MAKE:	# OF BLADES:
DIAMETER / PITCH:	MODEL:
PART #:	
OPTIONAL EQUIPMENT / OPTION PACKAGES	
TRAILER INFORMATION	
MAKE:	MODEL:
SERIAL #:	GVRM:
ADDITIONAL INFORMATION:	
DEALER	SPORTSMAN
NAME:	PHONE:
PHONE:	REPRESENTATIVE:
SALES PERSON:	ADDRESS:
SERVICE MANGER:	
ADDRESS:	

We recommend filling out the information in this table and keeping one copy of this page in your personal records and one copy with your owner's manual. This information will be important should you need to contact your dealer or Sportsman Boats Manufacturing for technical assistance and/or service.

SPECIFICATIONS



Length	26' 7"
Beam	9' 2"
Max HP	450
Fuel Tank Capacity	116 g
Useable Fuel Capacity	105 g
Freshwater Capacity	25 g
Main Livewell Capacity	21 g (x2)
In-Deck Fishbox Capacity (QT)	32
Draft (Up)	15"
Deadrise	16°
Approx. Dry Weight	4,600
Capacity	YACHT



FREQUENTLY ASKED QUESTIONS



Does the length include the engines or just the hull?

The length does not include engines. It is measured from the tip of the bow to the transom at the centerline of the boat.

Does the weight measurement include engines?

Due to this model offered with many different engine packages, the engine weight is not included in the estimated weight. It also doesn't include fuel, water, gear or batteries. If the boat is equipped with a top standard, the weight of that top is included.

What's the difference between tank capacity and usable fuel capacity?

Modern fuel systems require an air gap at the top of the tank to allow for expansion and contraction of fuel as temperatures fluctuate. This reduces the amount of fuel that can be fitted in the tank and is known as [ullage](#).

What does the "up" in Draft mean?

This denotes the amount of water the boat floats on with the engines "up" or completely out of the water.

What's the capacity of a Yacht Certified vessel?

All Sportsman Boats are [NMMA Certified](#) and under this certification boats over 26 feet are classified as Yacht Certified. This means that there is no explicit person capacity for this boat and it's the responsibility of the captain to operate within safe limits.

OVERALL DIMENSIONS & TERMINOLOGY

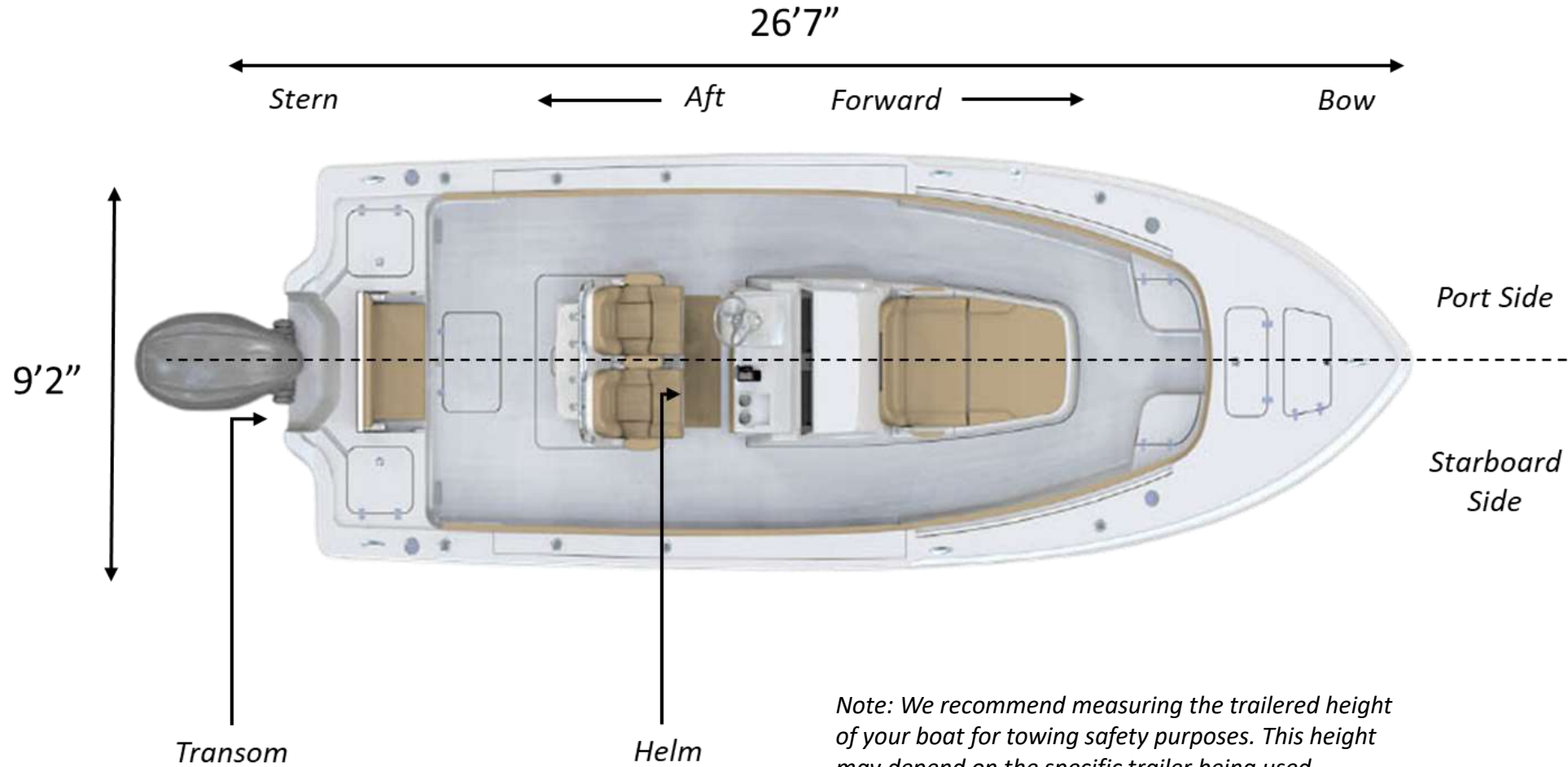

STANDARD FEATURES



Electronics, Console & Helm

SportLink® Electronics Integration System

Compass

Fiberglass Hard-Top w/ Integrated D-Tubing Frame

Garmin GPSMAP® 1243xsv MFD 12" w/ Bluechart G3

Garmin GT15M 600w CHIRP SS Thru-Hull Transducer

Garmin Signature 3i 8.8" 330w Coaxial Speakers (6)

Horn

Integrated Tempered Glass Windshield w/ Vent

Jack Plate (6" Hydraulic)

Lockable Console Storage

Seakeeper Ride VACS

Trolling Motor Plug & Harness

USB Audio Plug In-Dash & 12V Receptacle

Battery Switches & 2 Discover AGM Traction Batteries

Dash Panel Cover

Garmin Apollo™ Amplifiers - 150w RMS x 8CH (2)

Garmin Apollo™ RA770 Premium Stereo w/ SportTun

Garmin Signature 3i 6.5" 230w Coaxial Speakers (6)

Garmin VHF 115 Radio w/ Antenna

Integrated Hard-Top Navigation Lights (Lumitec)

Interior LED Lighting Package

King Fish Rod Holders

Matching Hard-Top Underside Color

SeaStar Interact DCM Digital Switching System

Underwater Lights

Seating, Upholstery & Pads

Bow Bolsters

Console Footrest w/ Storage & Pads

Premium Sileather® Marine Silicone Fabrics

Under Gunwale Reel Pads

Cockpit Bolsters

Helm Pad

Rear Fold Up Bench Seat w/ Storage

Under Gunwale Rod Racks

Livewells, Pumps & Storage

(1) 21 Gallon Rear Aquarium Livewell (Port)

(1) 32 Gallon Macerated In-Deck Fish Box

25 Gallon Freshwater Tank w/ Fluid Level Sensor & Washdown

Anchor Storage

Bow Storage Step Box

High Speed Livewell Pick Up

Step Storage Box

(1) 21 Gallon Rear Recirculating Aquarium Livewell w/ Pro-Air (STBD)

(1) 36 Gallon Bow Fish Box

Anchor Locker Freshwater Washdown

Bow Coffin Box - 270 Quart

Fiberglass Lining Post w/ Tackle Storage

Raw Water Washdown

Trolling Motor Battery Storage

STANDARD FEATURES (CONT'D)



Hull & Deck

SportTech® Advanced Fabrication Process	(4) Flush Mount Gunwale Rod Holders
10-Year Hull Warranty	116 Gallon Fuel Tank w/ Fuel Level Sensor
Advanced Fiberglass Stringer System (No Wood)	AlloChrome4200+™ Stainless Fasteners
Console Interior Liner	Dual Premium Seats on Fiberglass Leaning Post
Gemlux Cleats, Latches, Hinges & Rod Holders	Grip Tex Yacht Style Non-Skid
Large Rear Casting Deck	Light Hull Color
Rear Total Access Hatch	Recessed Bow Hand Rails
Self Bailing Cockpit	Stainless Steel Cup Holders - 8
Stainless Steel Drain Cover	Stainless Steel Propeller
Stainless Steel Rub Rail	Stainless Steel Steering Wheel w/ Knob
Swim Platform w/ 3-Step Ladder	Undertid Gaskets
Yacht & NMMA Certified	

* The information provided is intended for informational purposes only and is subject to change without notice. Information may be changed or updated without notice. Sportsman Boats may also make improvements and/or changes in the products, pricing and/or the programs described in this information at any time without notice. contact your local dealer for details. Not all options listed can be equipped at the same time. Some options may require other options.

POWER



Single Yamaha F300XSB
WHITE ONLY



Yamaha's V6 4.2-liter outboards are trusted favorites among offshore boaters for their power, efficiency, and reliability. They now come with integrated digital electric steering for improved responsiveness. These outboards offer convenient features like ample charging power, precise trolling control, compatibility with the Helm Master EX system and a theft-deterrent option. They also feature a new propeller for increased speed and smoother shifting, as well as quick and easy tilting and enhanced maneuverability in reverse.

Digital Controls

Integrated Steering

ENGINE TYPE	V6
DISPLACEMENT	4.2L
HORSEPOWER	300hp @ 5500 rpm
WEIGHT (EACH)	588 lbs

NEW Single Yamaha XF450NSA2
WHITE ONLY



The XTO Offshore® 450 packs everything boaters love about the original XTO outboard—the durability, power and reliability—plus extra horses. With impressive stats such as 12.3:1 compression ratio for impressive fuel economy and power and industry-first features such as an integrated electric steering system and Phase Angle Control Charging, it's purpose-built for the extremes of going offshore.

Digital Controls

Integrated Steering

ENGINE TYPE	V8
DISPLACEMENT	5.6L
HORSEPOWER	450hp @ 6000 rpm
WEIGHT (EACH)	963 lbs

NEW Single Mercury AMS 350 V10
BLACK OR WHITE



Mercury® 5.7L V10 350 and 400hp Verado® outboards continue the legendary Verado engine family's legacy of providing premium marine performance. With the strength of the outboard segment's first V10 naturally aspirated powerhead, they deliver extraordinary power and capabilities so you can confidently explore beyond the horizon.

Digital Controls

Electric Steering

ENGINE TYPE	V10
DISPLACEMENT	5.7L
HORSEPOWER	350hp @ 6400 rpm
WEIGHT (EACH)	695 lbs

NEW Single Mercury AMS 400 V10
BLACK OR WHITE



Mercury® 5.7L V10 350 and 400hp Verado® outboards continue the legendary Verado engine family's legacy of providing premium marine performance. With the strength of the outboard segment's first V10 naturally aspirated powerhead, they deliver extraordinary power and capabilities so you can confidently explore beyond the horizon.

Digital Controls

Electric Steering

ENGINE TYPE	V10
DISPLACEMENT	5.7L
HORSEPOWER	400hp @ 6400 rpm
WEIGHT (EACH)	695 lbs



NMMA Certification

Sportsman Boats is certified by the National Marine Manufacturers Association (NMMA). NMMA certification not only meets the standards of the United States Coast Guard (USCG) but goes further to meet the standards set by the ABYC (American Boat and Yacht Counsel). All Sportsman models have been designed, constructed, and thoroughly tested to meet or exceed these standards. For more information about these standards, you may visit <http://www.nmma.org/certification/boats>.

Hull Identification Number & Registration

Sportsman has a permanent record of your boat. This record is documented during the manufacturing process. It is identified by its "Hull Identification Number" (HIN). **The HIN is a 12-digit code located on the starboard side of the transom, just under the Rub Rail.** When contacting your dealer concerning maintenance or warranties, please have your HIN and model number available. This information can be found on your copy of the warranty card. Federal and State laws require a power boat to be registered in the state where it is primarily used. Registration numbers and validation stickers must be displayed according to regulations. The registration certificate must be on board when boating. The boat serial number, or Hull Identification Number (HIN), is required on the registration form. The HIN should be included on all documents or any correspondence.

LIGHTING

Your Sportsman boat is equipped with navigation lights which comply with both Inland and International rules.

FIRE EXTINGUISHER

At least one Type-1 handheld portable fire extinguisher must be carried on board. For boats over 20' two are required. Check extinguisher regularly for charge status.

REQUIRED SAFETY EQUIPMENT

The US Coast Guard (USCG) requires that every boat have specific equipment on board. Check with local regulations on mandatory equipment apart from the list of Coast Guard requirements.

SOUND SIGNALING DEVICES

Your Sportsman boat is equipped with an electric horn which meets the USCG requirements for a sound signal device.

PERSONAL FLOTATION DEVICE (PFD)

You must have a USCG approved personal flotation device of Type I, II, or III aboard for each passenger, in addition to one Type IV throw able PFD. **Always wear a PFD when boating.** In some states, children are required to wear a PFD at all times. Check your local regulations.

VISUAL DISTRESS SIGNALS

USCG approved visual distress signals are required for day and night use when operating on US waters. Approved signals include flares, orange smoke, an orange distress flag, or an electric distress light.

WARNING & DANGER LABELS



Being on the water is a great experience, but it can very quickly turn dangerous if the safety and maintenance instructions of your boat are not followed. Therefore, warnings and notices have been included in order to help you operate and maintain your boat safely. They are defined as follows:



Please become familiar with the location and content of the Caution, Warning, and Danger Labels found on your boat.

SAFETY ALERT SYMBOLS & LABELS



Your Owner's Manual was written to include safety instructions to ensure safe operations. Safety alert symbols are used to show potential personal injury hazards. Every precaution has been taken to reduce the risks associated with death, possible injury and damage from fire or explosion. You must also take your own necessary precautions and practice proper maintenance procedures in order to enjoy the optimal safe operation of your boat.

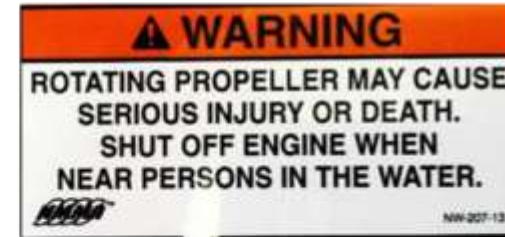
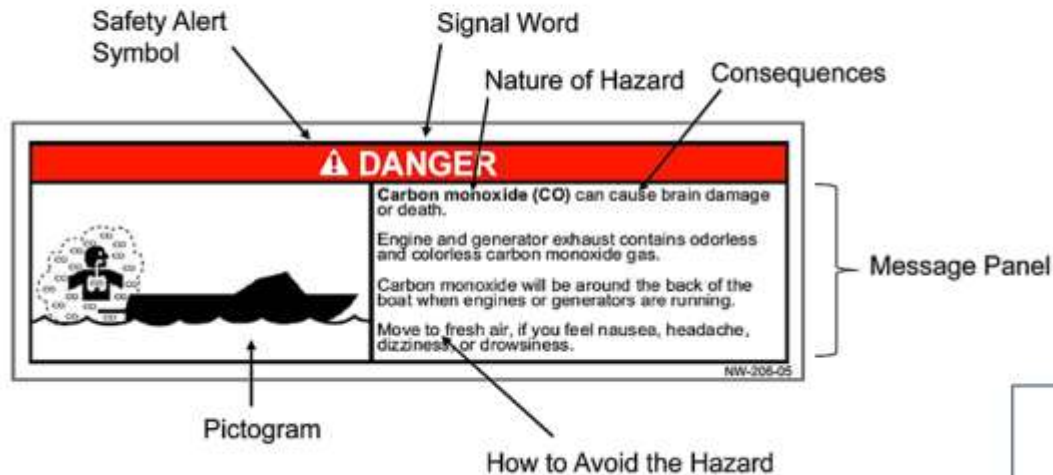

If your label is damaged, please call Sportsman's parts department for replacement stickers.

CARBON MONOXIDE WARNING



Your boat produces carbon monoxide and uses flammable fuel. Carbon monoxide can cause brain damage or death. Carbon monoxide is colorless, odorless and extremely dangerous.

⚠ DANGER



Carbon monoxide (CO) can cause brain damage or death.
Engine and generator exhaust contains odorless and colorless carbon monoxide gas.
Carbon monoxide will be around the back of the boat when engines or generators are running.
Move to fresh air, if you feel nausea, headache, dizziness, or drowsiness.

NW-208-13

⚠ WARNING

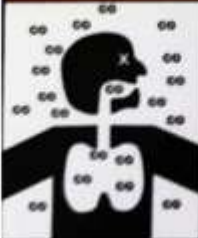

Carbon monoxide (CO) can cause brain damage or death.
Engine and generator exhaust contains odorless and colorless carbon monoxide gas.
Signs of carbon monoxide poisoning include nausea, headache, dizziness, drowsiness and lack of consciousness.
Get fresh air if anyone shows signs of carbon monoxide poisoning.
See Owner's Manual for information regarding carbon monoxide poisoning.

LABEL LOCATIONS

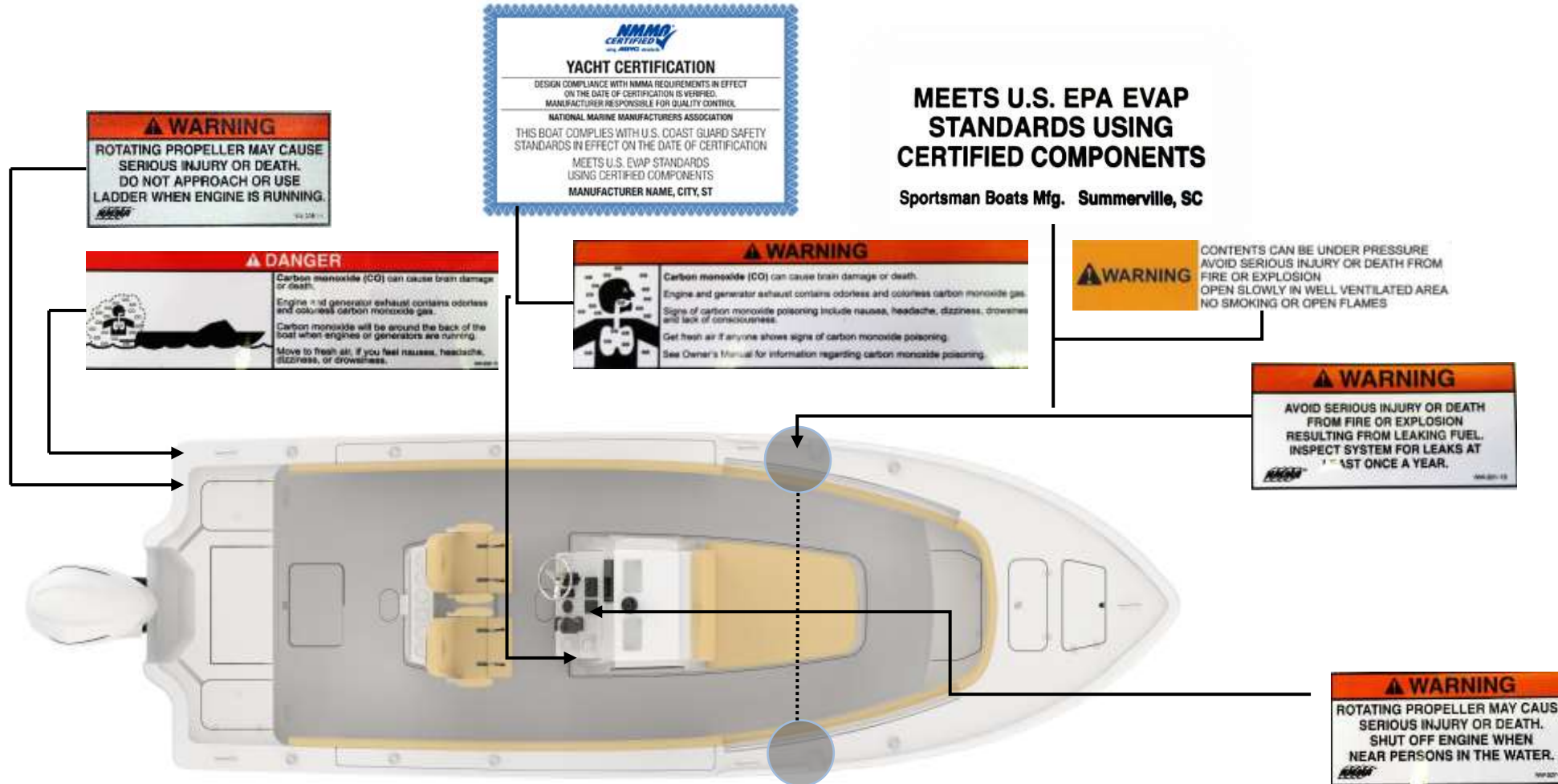

INVASIVE SPECIES WARNING



Aquatic Invasive Species (AIS)

Aquatic invasive species (AIS) are plants and animals that occur in waters in which they are not native and whose introduction causes or is likely to cause economic or environmental damage or harm to human health. AIS have a negative impact on the waterway, its native species, and recreational and commercial uses of the waterway.

As responsible boaters and citizens, each boat owner should do their part to prevent the spread of these aquatic hitchhikers. In many cases, it is also required by law. Check local regulations for any waterway where you will boat.

After each boating trip, follow these three simple steps before you leave the water access to stop the spread of AIS: Clean, Drain, and Dry. This is the boater's way to help protect the environment from the damage that AIS can cause.

Clean

Inspect and remove all aquatic plants, animals, mud, and debris from the boat, engine, trailer, anchor, and any watersports equipment.

Rinse, scrub or wash, as appropriate, away from storm drains, ditches, or waterways.
Rinse watercraft, trailer, and equipment with hot water, when possible.
Flush motor according to owner's manual.

Drain

Completely drain all water from the boat and its compartments, including but not limited to the bilge, wells, lockers, ballast tanks or bags, bait containers, engines, and outdrives.

Dry

Allow the boat to completely dry before visiting any other bodies of water.

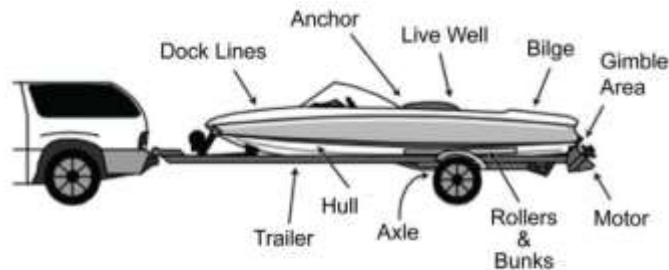

NOTE: Some localities may require inspection or decontamination before and/or after launching. Check state and local laws and regulations for requirements prior to traveling to go boating.

NAVIGATION SYSTEMS



Take control of your electronics with SportLink® Electronics Integration System, equipped standard on every Sportsman Boat. The Garmin powered electronics packages have been carefully designed around each model to meet and exceed your needs out on the water.

GARMIN GPSMAP® 1243 XSV MFD 12"

With its ultra-sleek design, vivid sonar color palette and high-resolution 12" in-plane switching display, this large format chart plotter/sonar combo offers improved sunlight readability and wide-angle visibility. Experience unparalleled coverage and detail with preloaded Bluechart® g3 coastal charts and LakeVü G3 inland maps featuring integrated Garmin and Navionics® content and Auto Guidance3 technology. It can also support FLIR cameras, GXM™ 53 marine weather receiver, VIRB® camera streaming and more. Network sharing allows you to share data among all compatible units connected to the network. Plus, it has built-in Wi-Fi® to support the ActiveCaptain™ app.



DIGITAL SWITCHING



SeaStar Maximus DCM Digital Switching System

The SeaStar Maximus DCM Digital Switching System eliminates the need to have physical switches on the dash. This not only cleans up the dash of switches, but it adds longevity to the electrical system of your boat. This is the way of the future and here at Sportsman Boats, we are leading the pack in innovation.



The system communicates through NMEA2000 to your Garmin MFD to add a screen that shows all of your 12v switches, doing away with the need to have physical toggle switches on the dash. You are able to customize the look and feel of the switches as well as create presets and modes with your favorite combination of lights. This type of flexibility is just not possible without digital switching.

To wrap it all up, it also includes a fob that allows you to operate the 8 most used functions on your boat from up to 100 feet away from your Sportsman Boat. This remote can even turn all power on or off on the vessel, redefining convenience and innovation.

DIGITAL SWITCHING (CONT'D)

Maximus DCM The Brain Powering The Digital Switching

At the heart of the system is the Maximus DCM. The module is mounted inside the console behind your electronics and provides a single source of power and fuses for all 12v accessories on the boat. One of the key features of the unit is the ease of being able to bypass the system and physically turn on any of the ports. The unit ships with all of the fuses in the normal position. Any of the fuses can be moved to the bypass position (as shown in the diagram) to override the system.

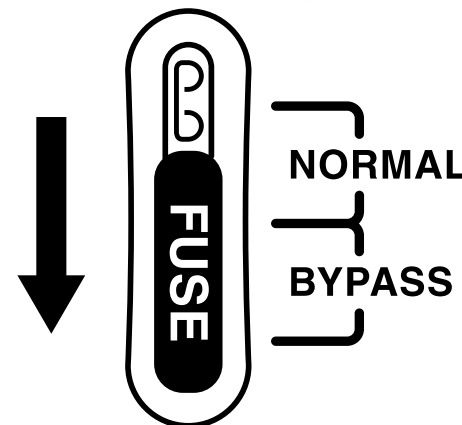

SPORTSMAN CUSTOM KEY FOB



8-Button Multi-Function Sportsman Remote

Hard-Top Lights: Operates the blue lights overhead on the Hard-Top

Spreader Lights: Operates the bright white LED lights located at the front and back of the top.

Courtesy Lights: Operates the blue ambient lighting located throughout the cockpit.

Underwater Lights: Operates the blue underwater lights.

Freshwater Pump: Operates the freshwater pump.

Raw Water Pump: Operates the raw water pump.

Power Button: Operates all power to the boat; very similar to the main battery switch, it will interrupt all power to the boat.

Navigation Lights: Operates the red and green navigation lights built into the rub rail at the bow.

LIGHTING



The **NAV/ANC Switch** is a 3-position switch on the console that controls the running lights.

- **NAV** position will turn on the red and green navigation lights and the white all-round light for night driving.
- **ANC** turns on the all-round light only for night anchoring. Do not operate the boat in anchor position.
- Off is in the center position.

Sidelights: The Master 267 has integrated rub rail navigational lights installed at the bow (see figure to the right). A green light is located on the starboard (right) side and a red light on the port (left) side of the vessel. Each shows an unbroken light over an arc of the horizon of 112.5 degrees and is fixed to show from ahead to just behind the beams of the vessel on its respective side.

All-round/Anchor Light: This is a white light placed over the highest unobstructed point of the vessel, showing an unbroken light over an arc of the horizon of 360°
See the figure to the right for location.



The anchor light is located on top of the T-top at the aft end.

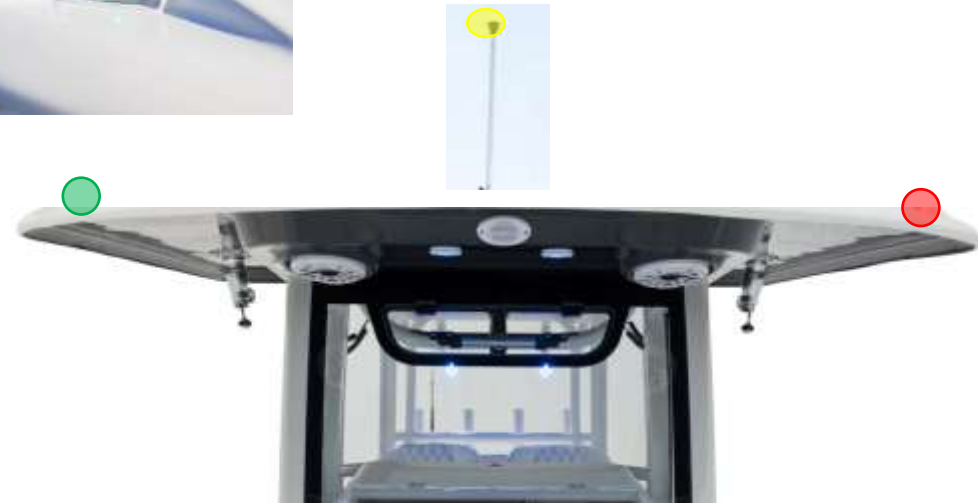

Recreational boats are required to display navigation lights between sunset and sunrise and other periods of reduced visibility (fog, rain, haze, etc.) Navigation lights are intended to keep other vessels informed of your presence and course. Your boat is equipped with the navigation lights required by the U.S. Coast Guard at the time of manufacture. It is up to you to make sure they are visible, operational and turned on.

When the sun goes down, molded in navigation lights can be found at the front corners of the hard-top. This location keeps them out of the way and completely unobstructed. Additionally, these Lumitec lights can dual purpose as docking lights with built in 1000 lumen white dock lights.

GARMIN FUSION AUDIO ENTERTAINMENT



GARMIN FUSION® AUDIO ENTERTAINMENT

Experience the soundtrack of the sea with Garmin Fusion®

Sportsman Boats is an exclusive partner of Garmin Fusion® Audio Entertainment. This page outlines the audio systems and provides more information on the components that we use throughout our boats. Some of the equipment shown are optional items and not available in all models.

FUSION® APOLLO™ MARINE STEREO

The world's first touchscreen marine stereo with the AirPlay® 2 software feature and built-in Wi-Fi® connectivity, Apollo RA770 has redefined audio excellence with revolutionary technology and innovative design. The Apollo RA670 marine stereo inherits key audio innovations and revolutionary technology from the award-winning Apollo RA770, reimagined in a compact form factor.

Fusion® Apollo™ MS-RA770 Marine Stereo

Standard on all boats 26' and up and available as an upgrade for boats 25' and down.



SPORTTUUN

CUSTOM TUNED AUDIO DSP SYSTEM

HOW IT WORKS

When it comes to audio on a boat, modern technology has greatly improved the sound quality and durability of the components. The All-New SportTuun Custom Tuned DSP System is an exclusive audio profile that was developed by the Garmin engineering team for our boats. The system is powered by Garmin's Digital Signal Processing or DSP system that was previously only available in our upgraded systems. A DSP-equipped system is able to process the sound signal being sent to each speaker to adapt it to its environment. This delivers the truest sound to the listener's ears, regardless of the acoustical properties of the boat.

A PROFILE PER MODEL

Each model has been analyzed and a sound system has been designed around the space available. Then, each system will receive a model-specific profile that enhances the components, acoustics, proximity to the listener and overall layout of the boat. This ensures that every model leaves the factory sounding just like the Garmin team intended.

WARRANTY & SUPPORT

The SportTuun System is part of our SportLink® System which comes with a standard 3-Year Warranty. You will also enjoy 3 years of on-board support as part of these additional perks. This is an exclusive agreement for Sportsman Boat Owners.

GARMIN APOLLO AMPLIFIERS



This 8-channel amplifier with 150-watt RMS per channel can power up to eight pairs of speakers or four pairs of speakers and two subwoofers. It includes high-power mode adapters for simple bridging to increase power.

- *Some amplifiers distort audio when they add power. Ours are specifically designed with minimal distortion and noise, so you can enjoy high-quality audio, even at higher volumes.*
- *The amplifiers are designed to last season after season. They have been tested to a high level of protection against salt fog, temperature, vibration and UV.*
- *The ignition protected design helps prevent potential damage from overheating.*



BILGE PUMPS



Two small bilge pumps are located on the hull bottom at the stern of your boat. Water is pumped out of thru-hull fittings located on the port and starboard sides of the boat near the transom. The pumps may be accessed by removing the aft seat and door, in the area shown to the right. You may turn your bilge pumps on manually by flipping on a bilge switch located on the switch panel at the helm. Additionally, the bilge pump utilizes a float as an automated switch to turn it on automatically if necessary when the boat is unattended. The bilge pumps are designed to remove excess water **only**, and they are **not** intended to stop or prevent rapid accumulation of on-board water due to rough weather, hull damage, or any other unsafe navigational conditions.



The rear seat easily opens to allow easy access to the bilge area at the stern.

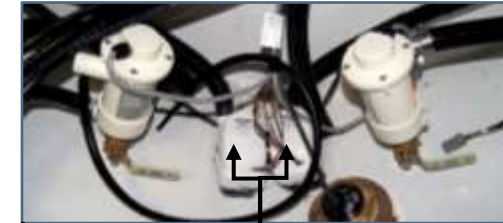

Bilge Pumps

Drain Outlets

LIVEWELLS

The Sportsman 267 comes with a 21-gallon rear livewell, one 35-gallon recirculating livewell at the stern of the boat and one 14-gallon recirculating livewell in the bow of your boat. For easy access to the pumps and plumbing systems, open the total access hatch forward of the transom. The livewell pumps are located on either side of the bilge pump in the hull of the boat, and the livewell fill hoses are connected to the top of the pumps. To operate the livewells, turn on the livewell switch at the helm and turn the fill valve in the livewell to “open.” To operate the starboard aft livewell and the console livewell, use the switch labeled “Livewell 1.” To operate the port aft livewell, use the switch labeled “Livewell 2.” All livewells are equipped with overflow drains so water cannot exceed a certain level and overflow. These overflow drains are connected to the main drain lines at ‘T’ joints, which empty out an outlet drain at the stern of the boat. Additionally, each livewell has LED lighting installed. To illuminate the livewells, turn on the switch at the helm.

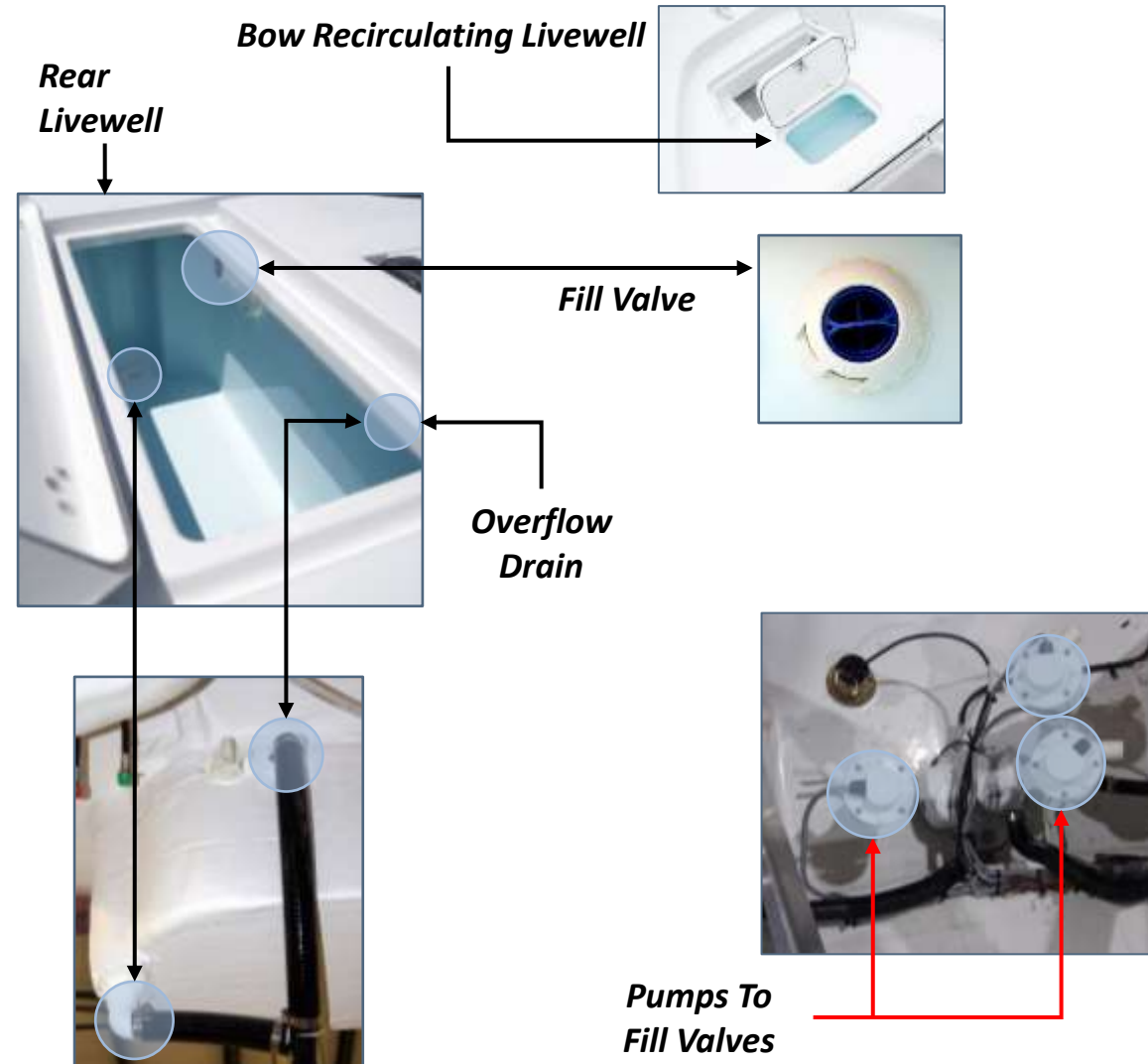

LIVEWELLS (CONT'D)



The Sportsman Masters 267 OE has a recirculating livewell as a standard feature. The starboard aft livewell is equipped with an aeration and recirculation system. The two black strips on the inside walls of the livewell are part of the aeration system. The air pump (mounted on the side of the livewell) pushes air through the air stone at the base of each strip, which produces air bubbles to oxygenate the water. This feature is best for keeping bait alive overnight or for use when the boat is not in use, because it draws very little power. The recirculation system features an intake (with a strainer cover, shown in the figure) and an outlet water jet. The jet is mounted in the corner of the livewell in order to allow for optimal water recirculation when in use. The recirculation pump is a white tsunami water pump mounted on the side of the livewell. This system is operated with a 3-way switch at the helm of the boat. The system is off with the

switch in the middle position. With the switch up, the aeration system alone will run, which draws very little power. With the switch down, both the aeration and recirculation systems will run. The figure here displays most of the important features of the recirculating livewell system.

Note: The set-up in this figure is not exactly like the set-up in your boat. This is just a simple representation of the major features for this system. The exact mounting locations will be different in your boat than the locations shown here.

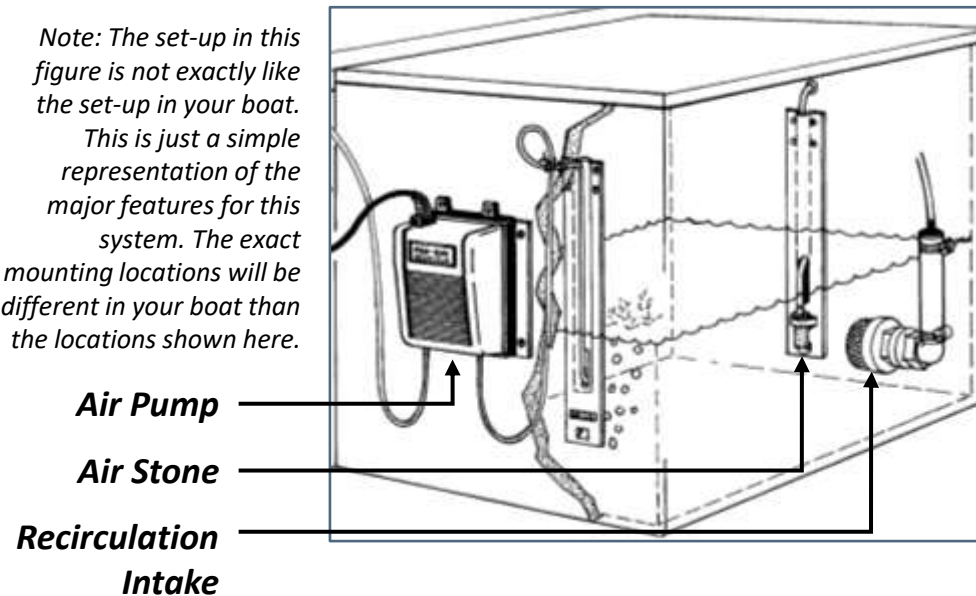

RAW WATER WASH-DOWN



The Masters 267 OE has the raw water wash-down installed as a standard feature. Rinsing your boat immediately after use with a powerful water jet helps to maintain the boat's condition and value. This system supplies water via a hose connected to bottom of the same pump that supplies water to your livewells with a shut off valve in the bilge area at the total access hatch. To operate the wash-down system, start by opening the valve mentioned above. Then turn on the switch labeled "RAW WATER" on the dash at the helm. The wash-down outlet is found on the starboard side of the boat under the gunwale. See the figures here for important feature locations for the raw water wash-down system.

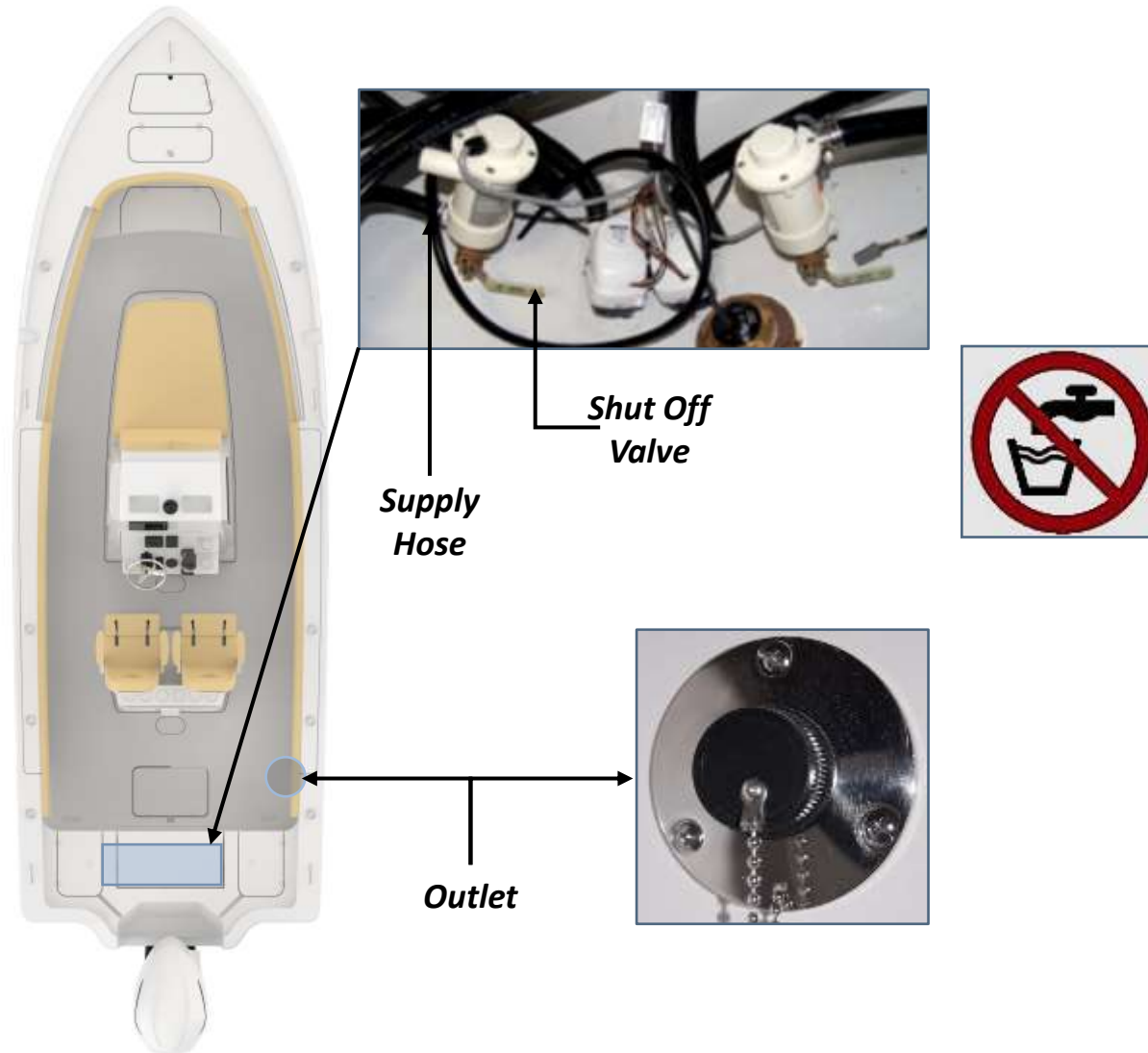

FRESH WATER WASH-DOWN

The Masters 267 OE has the freshwater wash-down installed as a standard feature. The freshwater fill fitting is located under the bow step lid. **Do not leave the tank full if your boat will be left unattended for an extended period of time;** pump the tank dry to avoid stagnant water in the tank if necessary. It is also important to periodically inspect and clean the filter, which is located on the pump. To operate this system, turn on the switch labeled “FRESH WATER” at the dash. This will pressurize the system for use. When the tank is empty or the boat is not in use, ensure that this switch is in the off position.



PORCELAIN HEAD



The Quiet-Flush Toilet provides a quiet operation, with user control of the flush. A single large push button switch provides a simple flush mode by activating both the rinse water supply and the macerator discharge pump simultaneously. An additional rocker switch offers independent control of the rinse water supply and discharge pump separately so the bowl water level can be raised and lowered by the user. The rinse water is supplied from the 25-gallon water tank in the starboard stern of the boat.



HALF TOWER OPTION



This option gives you an elevated platform designed to give the captain a better view, enabling visibility at a much greater distance. With a touch of the Station Selector button. You will steer the boat, use the throttle shifter, control the trim tabs, raise or lower the Jack Plate and have use of a 9" Garmin.



FUEL TANK



The Masters 267 OE comes with a fuel tank installed (approximate usable 108-gallon capacity). The gasoline fuel system consists of a fuel tank (located underneath the helm seat as shown in the figure), anti-siphon valve, engine fuel supply line, and fill cap. Your boat contains a new EPA certified fuel system. The system prevents spit-back when filling the tanks and lowers the out-gassing emissions through a vent in the new designed fuel fill cap.

Note: This photo was taken during the assembly process. At this stage, some of the hoses had not yet been connected. In your boat all lines and hoses will be connected as necessary.

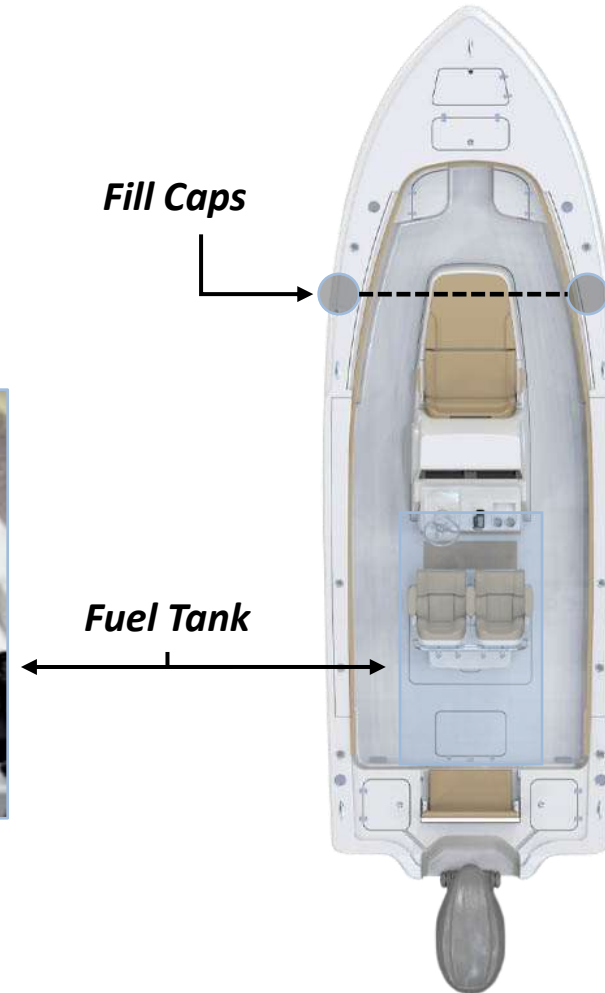

To access some fuel hose connections, you must remove the stick-on helm mat between the leaning post and the console



EPA DIURNAL FUEL SYSTEMS

NOTE: Pressure may be present when opening your deck fill, regardless of system type.



Only open the fuel cap for refueling

Note: The first time fuel is introduced to a fuel tank, be aware of the interaction of cold raw fuel vapors replacing air, on occasion a vapor pressure can occur producing spit-back anomalies!

What is a diurnal fuel system?

Your new vessel is equipped with an Environmental Protection Agency (EPA) compliant diurnal fuel system, designed to reduce fuel emissions to atmosphere using criteria mandated by the EPA. Your vessels fuel tank is required and designed to have a positive pressure (>1PSI) as the sun heats the boat and the fuel in the tank expands or it may be equipped with a carbon canister to catch and contain fuel vapors

Your boats fuel tank also has valves installed inside that are designed to:

1. Produce a clean refueling shut off event
2. Create a 5% vapor space
3. Reduce the propensity of a refueling spit-back event.
4. Allow for appropriate venting when the vessel is stored or trailered. Your fuel cap also contains valves designed to retain fuel vapor (up to 1PSIG) and to allow make up air during engine operation

REFUELING MANAGEMENT



Vapor Space (Ullage) And Refueling Management

Another fuel system necessity to remain EPA compliant is to keep elevated temperature gasoline from expanding into fuel areas that are not low permeation rated or otherwise sensitive to raw fuel. A vapor (or ullage) space must be produced at the completion of the filling or refueling operation to ensure systems remain EPA compliant during the diurnal temperature cycle. To effectively manage this system function, BluSkies has created a series of valves that can mount to any marine fuel tank to achieve the appropriate fill level while maintaining ullage space of -5%. Additionally, these valves eliminate the propensity for refueling “spit-back” or tank “well-back”, which is another requirement of the EPA regulation. BluSkies primary ullage valves replace the existing fill and vent locations, while additional grade or tip level valves can be added to any tank to meet American Boat And Yacht Council standards (H-24) which allows vapor venting for boats slanting or sloping when stored, moored, parked or trailered.

The final decision on which system type and ullage valve type and placement that is best for your application should be based on application specific factors such as type and configuration of fuel tank, how much room there is on board for added components, how are the boats likely to be used and stored, and cost.

Chose individual components to create a compliant system from the following pages or turn to our specialists for sound guidance and direction as you go through the process of choosing the appropriate system for your particular vessel application.

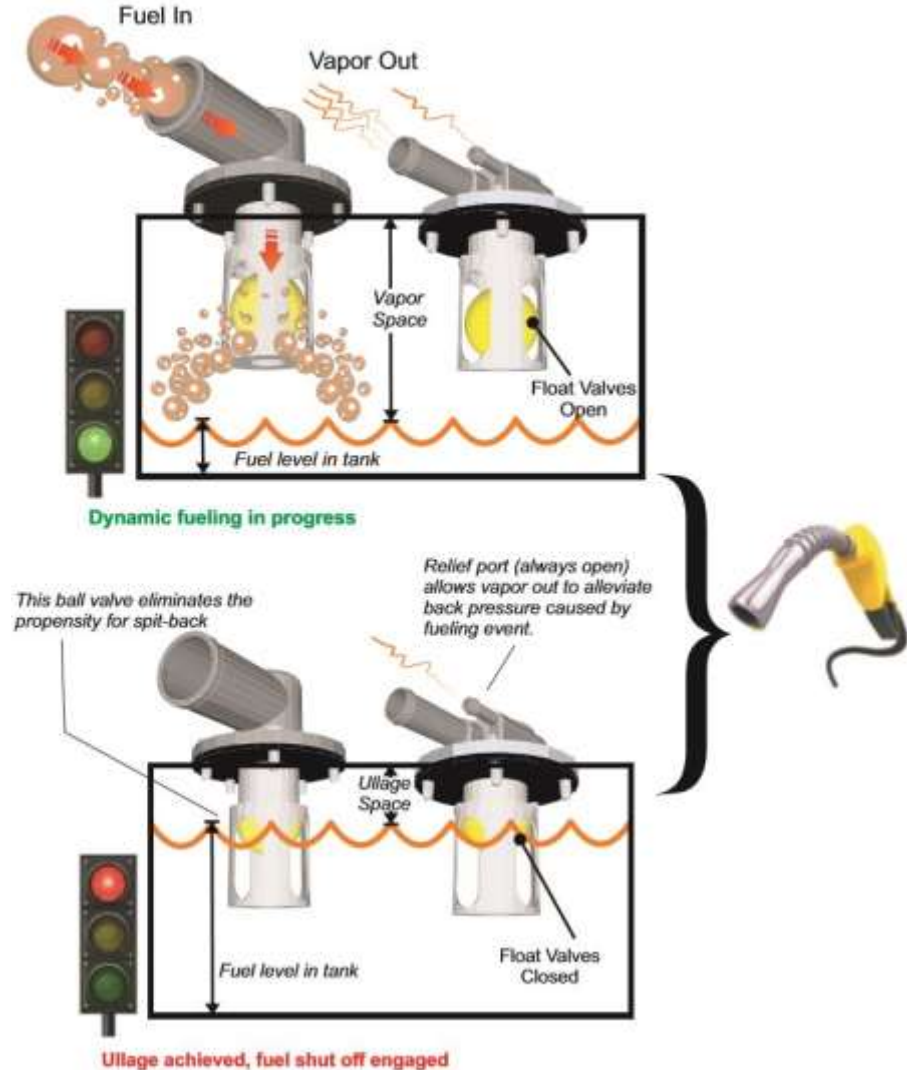

TANK ULLAGE MANAGEMENT



Ullage (Vapor Space) Level Attainment Spit-back/Well-back Control

This vent valve shuts off the refueling vapors and creates back pressure to lift the fill valve ball into place.

This fill valve ball is set lower than the vent valve ball but does not close until the refueling vapors are shut off by the vent valve.

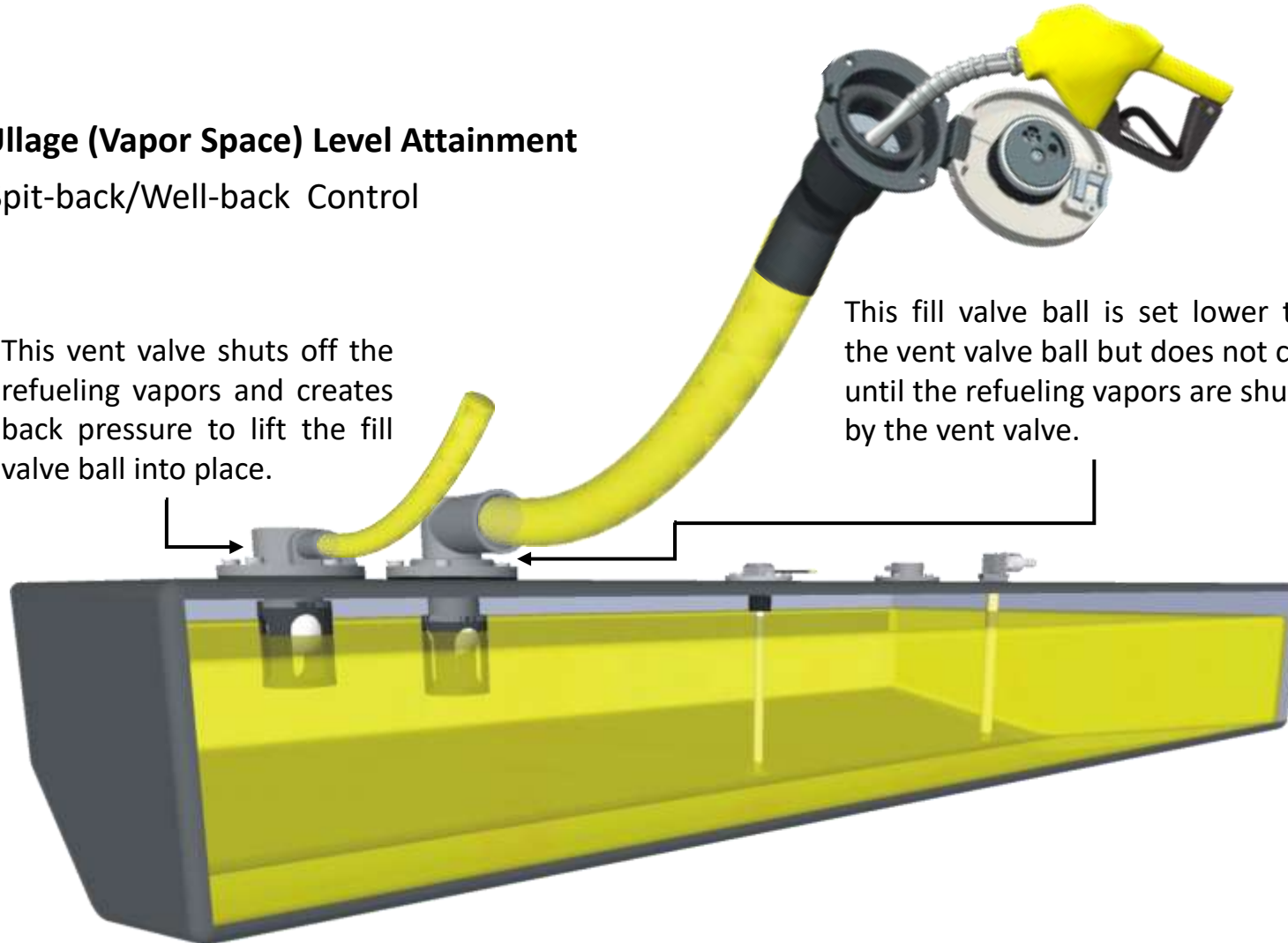

REFUELING NOTICE



Your fuel tank capacity will vary from the label or published capacity no less than 5% by law and up to 10% dependent upon the variation from static float due to equipment, occupants and gear etc. (Static Float = attitude in which your boat floats in calm water)

Fill your vessel fuel tank as normal, stop refueling after two (shut off) clicks of the fuel nozzle.

Topping off will over ride your fuel system design intent and could cause damage to your vessel due to overflow and will void any and all warranty claims related to fuel spillage.

BluSkies is expressly not responsible for any damage to your vessel subsequent to topping off.

WARNING

CONTENTS CAN BE UNDER PRESSURE
AVOID SERIOUS INJURY OR DEATH FROM
FIRE OR EXPLOSION
OPEN SLOWLY IN WELL VENTILATED AREA
NO SMOKING OR OPEN FLAMES

It has been a common practice for many years to top off boats prior to storage or in preparation for a day on the water, however diurnal fuel systems are designed specifically to leave a space in your fuel tank to allow the fuel to expand during the heat of the day. GASOLINE EXPANDS 5%.

REFUELING

GASOLINE CONTENTS UNDER PRESSURE. FUEL SPRAY MAY OCCUR.

1. OPEN CAP SLOWLY
2. INSERT FUEL NOZZLE
3. BEGIN & CONTINUE FUELING UNTIL FUEL NOZZLE KICKS OFF
4. WAIT 10 SECONDS & CONTINUE FUELING UNTIL NOZZLE KICKS OFF A SECOND TIME
5. RETURN NOZZLE TO PUMP
6. DO NOT TOP OFF

ETHANOL & FILTER WARNING



What is Ethanol and Why Is It Bad for Outboards?

Ethanol has been added to most of today's fuel supply as an oxygenate to help reduce emissions. It's also used to extend domestic fuel supplies.

Ethanol is alcohol, and alcohol is "hygroscopic", which means it attracts water molecules. Since nearly all outboard fuel tanks are vented to the atmosphere, water can (and will) collect in your fuel. When the concentration of water molecules in your fuel tank reaches just 1/2 of 1%, the water molecules will bond with the alcohol and sink to the bottom, where your fuel pick up is. Depending on the amount of water ingested into your outboard, this can result in everything from running problems to catastrophic damage.



Ethanol, being alcohol, is also a powerful solvent that can loosen debris in your fuel tank and all the tanks and lines it was in before it got to you. Once in your outboard, this debris can cause everything from running issues to a no-start, no-run condition.

Fuel/Water Separating Filter

This filter is in the outboard fuel line between your fuel tank and your outboard. It filters the gas and allows any water (which is heavier than gas) to safely sink to the bottom of the filter and out of the fuel. Yamaha's spin-on 10-micron filter traps impurities down to 10 microns in size (1/20th of the diameter of a human hair) to keep your fuel clean, and it has an extra-large water-retention area. And since it's a spin-on, it's very easy to replace.

Tip: Carefully filling a new replacement filter about 3/4 full with fresh, stabilized fuel before installation will make priming the fuel system afterward much quicker and easier.

Tip: Apply a thin film of clean engine oil to the fuel filter gasket before installing the new fuel filter. That will make it much easier to remove when it's time.

10-micron filters should be replaced every 50 hours of engine operation. Keeping this filter clean and fresh will help protect the other fuel filters on the engine and extend their service life. And always carry a spare on board, just in case you get a load of bad gas and the filter gets overwhelmed.

Tip: Do not simply remove and dump the fuel and re-install the filter, as captured debris and water could enter the "clean" side of the filter and be released into your fuel system.

BOATING NAVIGATION GUIDELINES

There are three main situations that you may encounter with other vessels which could lead to a collision unless the Steering Rules are followed:

- Meeting:** you are approaching another vessel head-on
- Crossing:** you are travelling across the path of another vessel
- Overtaking:** you are passing or being passed by another vessel

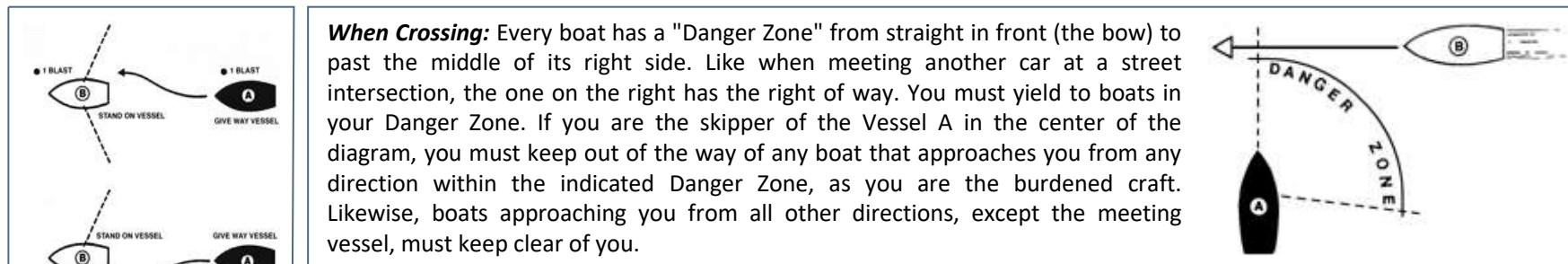
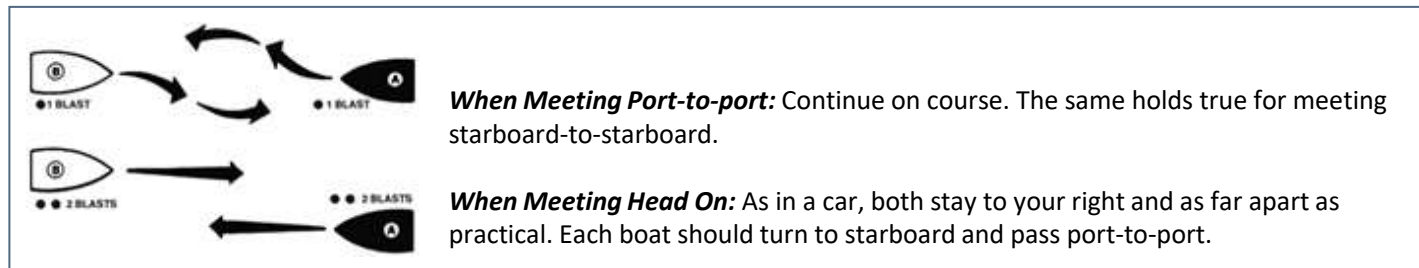

When Overtaking Another Boat: The boat being overtaken is the privileged vessel. Only after signaling and receiving an acknowledgment can the overtaking boat pass (Use one blast to pass on the right, and two blasts to pass on the left).

When Being Overtaken: Be ready for trouble when a power boat passes you in a narrow waterway. As the lead boat, which always has the right of way, stay on your side of the channel and maintain a steady speed so that the overtaking vessel can pass you safely. Use your radio to discuss this with the passing boat.



Product Changes

Sportsman is committed to the development of our product line. As a result, equipment described in this manual may have changed or may no longer be available. All information, illustrations and specifications contained in this manual reflect the latest product information available at the time of publication. Sportsman reserves the right to make changes to its boats at any time, without notice. These changes include, but are not limited to, color options, materials, standard and optional equipment, specifications and model availability. If you have any questions about the equipment on your boat, please feel free to contact Sportsman.

Insurance

In most states, the boat owner is legally responsible for damages or injuries they or anyone else operating the boat causes. Some states have laws that require having at least minimum coverage. Before using your boat for the first time, you should contact your dealer, current insurance company, or state boating authority for information regarding insurance requirements in your area. Although it may not be required in your area, responsible boat owners carry liability and property damage for their boat. You should also protect the boat against physical damage and theft.

Service

All warranty work must be performed by an authorized Sportsman Dealer. If a problem is discovered upon taking delivery of or develops during routine use of the boat that is related to faulty workmanship and/or materials, as stated in the warranty, you need to contact your Sportsman dealer to arrange for your boat to be repaired. **The boat owner is responsible for delivering the boat to the dealer for warranty service.** If you are not near your dealer or any other authorized Sportsman dealer, please contact Sportsman. Likewise, if the dealer fails to repair the problem, please notify Sportsman within 14 days of the work being completed. **Sportsman will not reimburse owners for unauthorized warranty work.**

SPORTSMAN BOATS LIMITED WARRANTY



Ten-Year Hull Limited Warranty: This Limited Warranty applies to any Structural Hull Defect (as that term is defined below) if such is due to a failure in material or workmanship and the same was reported to Sportsman according to the terms of this Limited Warranty within ten (10) years from the date of the sale to the original purchaser of the Sportsman authorized dealer. Sportsman, in its sole discretion, will either repair or replace the Hull. For purposes of this Limited Warranty, the term “Hull” shall mean the single fiberglass molded shell and integral structural components of a Sportsman Boat, and the term “Structural Hull Defect” shall mean a substantial defect in the Sportsman Boat’s Hull that causes the boat to be unfit or unsafe for general use as a pleasure craft under normal operating conditions.

One Year Nonstructural Limited Warranty: This Limited Warranty applies to any Nonstructural Defect (as that term is defined below) if such is due to a failure in material or workmanship and the same was reported to Sportsman according to the terms of this Limited Warranty within one (1) year from the date of the sale to the original purchaser of the Sportsman Boat by a Sportsman authorized dealer. Sportsman, in its sole discretion, will either repair or replace the defective component. For purpose of this Limited Warranty, the term “Nonstructural Defect” shall mean a substantial defect in a Sportsman Boat’s components manufactured or installed by Sportsman (other than the Hull) that is not excluded in the exclusions below.

Registration and Transfer of Limited Warranty: Each original purchaser of a Sportsman Boat shall complete and return the boat registration card provided by Sportsman within thirty (30) days of such owner’s purchase of the boat in order to facilitate the processing of warranty claims and for manufacture notification. Except where a Sportsman Boat has been salvaged and resold after a declaration of a total loss or a constructive total loss, this Limited Warranty is transferrable to a subsequent owner of the Sportsman Boat. PROVIDED SUCH SUBSEQUENT OWNER FILL OUT AND SEND TO SPORTSMAN A SPORTSMAN WARRANTY TRANSFER FORM (AVAILABLE FROM SPORTSMAN ON REQUEST). A COPY OF THE BILL OF SALE, WITHIN THIRTY (30) DAYS OF SUCH TRANSFER OR PURCHASE.

LIMITED WARRANTY EXCLUSIONS



This limited Warranty does not apply to any boat that has been salvaged or declared a total loss or constructive total loss for any reason not specifically covered in this Limited Warranty. In addition, this Limited Warranty does not apply to the following "Exclusions:"

- | |
|---|
| 1) A Hull, component, or other product that has been repaired without authorization of Sportsman or that has been altered in any way that affects its use and operation; |
| 2) Expenses related to inspection or warranty service for hauling out, transportation to and from any dealer or Sportsman factory, towing or storage charges, inconvenience or loss of time or income; |
| 3) Engines, outdrives, controls, propellers, engine brackets, stereos, depth finder, GPS units, trolling motors, batteries, outriggers bases and other equipment or accessories that are not manufactured by Sportsman, whether the same is or is not warranted by such other manufacturer; |
| 4) Blistering, discoloring, cracking, or crazing of the Gelcoat finish or other surface finishes; |
| 5) Any Sportsman Boat initially sold at retail by a party other than an authorized Sportsman dealer; |
| 6) Damage to, breaking of, or leakage around any windshields, hatches, or apertures; |
| 7) Any zippers, vinyl, upholstery, plastic or fabric components; |
| 8) Discoloration, oxidation, bleeding, or corrosion of any stainless steel or other metal products; |
| 9) Any Hull, component, or product that has been subject to unreasonable use, tampering, abuse, mishandling, improper maintenance, negligence, improper trailing, alterations, or accidents; |
| 10) Any boat, or component or part thereof, that has been used for Commercial Purpose, racing purposes, or has otherwise been operated contrary to any printed instruction provided by Sportsman or contrary to any applicable law (for purposes of this Limited Warranty, the term "Commercial Purposes" shall mean the usage of any boat more than fifty percent (50%) for revenue-producing or other business purposes); |
| 11) A boat, or component or part thereof, that has been overpowered according to the maximum recommended engine horsepower specified on the capacity plate attached to the boat; |
| 12) Machinery, equipment and accessories not installed by Sportsman; |
| 13) Condensation of gauges; |
| 14) The failure of any part, area, or component of the boat to be dry, whether or not the same was represented as "dry"; |
| 15) Any representation relating to the speed or weight of any part or component of the boat; |
| 16) Normal wear and tear maintenance items, including, but not limited to, filters bulbs, batteries, bungees, anchor rope, trailer finishes, tires, brakes, bearing, and lights; |
| 17) Any defect or repair requiring redesign of the boat, except pursuant to the recall provisions of the United States Federal Boat Safety Act of 1971 or the recall laws of any other foreign jurisdiction; |
| 18) Dealer preparation, cleaning, and final adjustments and alignments in preparing the boat for delivery or commissioning; or |
| 19) Any act of God or force majeure. |

Thank you for your purchase of your Sportsman Boat.

Sportsman Boats Manufacturing, Inc.
113 Sportsman Way · Summerville, South Carolina 29483
Telephone (843) 376-2628

Email

sales@sportsmanboatsmfg.com

Website

www.sportsmanboatsmfg.com

P.O. Box 2100
Summerville, SC 29484

