

OPEN
S
282TE

SPORTSMAN

SPORTSMAN

*Owner's Manual and
Quick-reference Guide
2022*

Introduction



WELCOME TO THE SPORTSMAN TEAM!

Here at Sportsman Boats, we take great pride in producing the finest, most well designed saltwater fishing and pleasure boats on the market today. Our designs incorporate the most modern technology while applying good old “Common Sense” technology as well. From our advanced composite construction, ergonomic console designs, patented “Total Access” hatch, and superior ride and handling characteristics, we think you will agree that Sportsman is setting a new standard. Sportsman Boats builds the fastest growing line of family-friendly center console boats in-class, built with the latest designs, procedures and materials to give you and your family unparalleled performance with a dry, safe and comfortable ride

We do not take lightly the confidence you have placed in us with your decision to purchase your Sportsman boat. We will always strive to provide for you and your family the superior customer service you deserve. We hope that you enjoy your time out on the water as much as we enjoy building your Sportsman boat!

Safe Boating and Tight Lines,
Tommy Hancock

SPORTSMAN

Important Information



BOAT INFORMATION / SPECIFICATIONS	
MODEL:	HULL SERIAL #:
PURCHASE DATE:	DELIVERED:
IGNITION KEY #:	REGISTRATION #:
DRAFT:	WEIGHT:
VERTICAL CLEARANCE:	
ENGINE / PROPELLER INFORMATION	
ENGINE MAKE:	MODEL:
ENGINE SERIAL #:	
PROPELLER MAKE:	# OF BLADES:
DIAMETER / PITCH:	MODEL:
PART #:	
OPTIONAL EQUIPMENT / OPTION PACKAGES	
TRAILER INFORMATION	
MAKE:	MODEL:
SERIAL #:	GVRM:
ADDITIONAL INFORMATION:	
DEALER	SPORTSMAN
NAME:	PHONE:
PHONE:	REPRESENTATIVE:
SALES PERSON:	ADDRESS:
SERVICE MANGER:	
ADDRESS:	

We recommend filling out the information in this table and keeping one copy of this page in your personal records and one copy with your owner's manual. This information will be important should you need to contact your dealer or Sportsman Boats Manufacturing for technical assistance and/or service.

Specifications



Length

28' 5"

Beam

9' 10"

Max Horsepower

600HP

Fuel Tank Capacity

230 gal.

Approx. Usable Fuel Capacity

210 gal.

Freshwater Tank Capacity

20 gal.

Transom Aquarium Livewells (x2)

30 gal.

Bow Coffin Box

345 qt.

In-Deck Fish Boxes

140 qt. (x2)

In-Deck Bow Storage Box

286 qt.

Draft (up)

23"

Deadrise at Transom

22°

Approx. Dry Weight

7,379 lbs.

Yacht Certified

Yes

SPORTSMAN



Overall Dimensions & Terminology

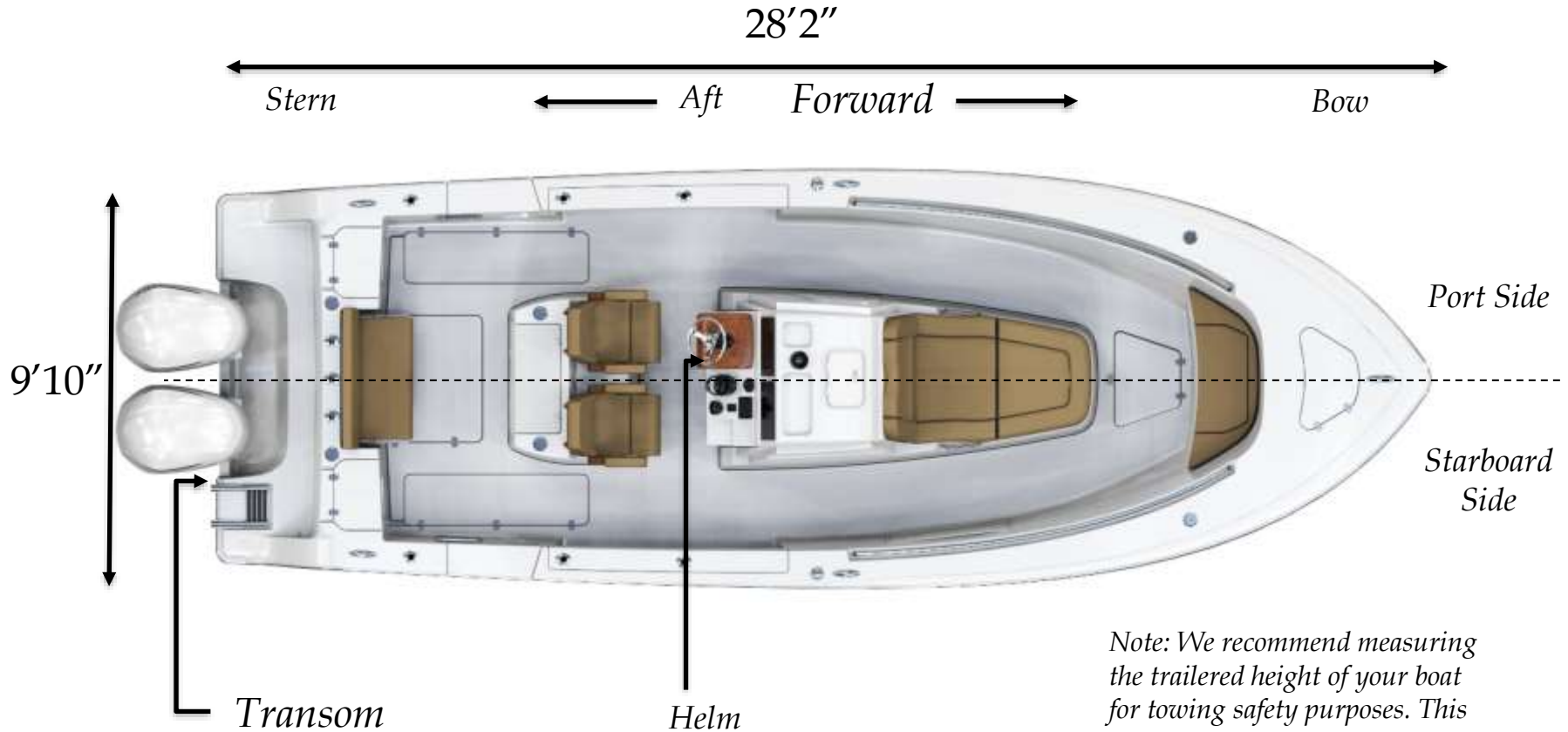

Note: We recommend measuring the trailered height of your boat for towing safety purposes. This height may depend on the specific trailer being used.

SPORTSMAN

Standard Features



Electronics, Console & Helm

SportLink® Electronics Integration System
Garmin GPSMAP® 1243xsv 12" w/ Bluechart G3
Garmin Fusion® Apollo™ RA670 Marine Stereo
Garmin VHF 115 Radio w/ Antenna
SeaStar Maximus Digital Switching System
Airmar B60 Thru-Hull Transducer
Anchor Windlass System w/ Anchor & 300' Line
Battery Switches & 3 Batteries
Compass
Dash Panel Cover
Fiberglass Hard-Top w/ Integrated D-Tubing Frame
Horn
Integrated Hard-Top Navigation Lights (Lumitec)
Integrated Tempered Glass Windshield w/ Actuated Vent
Interior LED Lighting Package
JL Audio M3-650X Gloss White Sport Grille Speakers (6)
Lockable Console Storage
Matching Hard-Top Underside Color
Porcelain Head w/ Overboard Discharge & Pump Out
Trim Tabs w/ LED Indicator
Underwater Lights
USB Audio Plug In-Dash & 12V Receptacle

Livewells, Pumps & Storage

(2) Macerated In-Deck Fish Boxes
20 Gallon Freshwater Tank w/ Washdown
(2) 30 Gallon Aquarium Livewells
55 Quart Bow Step Box w/ Pad
286 Quart Bow In-Floor Storage
345 Quart Macerated Bow Coffin Box
Raw Water Washdown

Seating, Upholstery & Pads

Bow Bolsters
Built-In Console Chaise Lounge
Cockpit Bolsters
Console Footrest w/ Pads
Helm Pad
Premium Sileather®
Marine Silicone Fabrics
Rear Fold Down Seat

Hull & Deck

SportTech® Advanced Fabrication Process
(6) Flush Mount Gunwale Rod Holders
10-Year Hull Warranty
230 Gallon Fuel Tank w/ Fuel Level Sensor
Advanced Fiberglass Stringer System (No Wood)
Built-In Swim Platform w/ 4 Step Ladder
Console Interior Liner
Dual Fuel Fills
Dual Premium Seats on Fiberglass Leaning Post
Dual Side Entry Doors w/ Removable Ladder
Grip Tex Yacht Style Non-Skid
Light Hull Color
Port and Starboard Toe Rail
Powder Coating
Pull-Up Cleats
Recessed Bow Hand Rails
Self Bailing Cockpit
Stainless Steel Cup Holders - 10
Stainless Steel Drain Covers
Stainless Steel Propeller
Stainless Steel Rub Rail
Stainless Steel Steering Wheel w/ Knob
Under Gunwale Rod Racks
Underlid Gaskets
Yacht & NMMA Certified

SPORTSMAN



Features & Performance

Optional Features

- SECOND GARMIN GPSMAP® 1243XSV 12"
- GARMIN GMR™ 424 XHD2 OPEN ARRAY
- GARMIN GMR™ FANTOM 18 RADOME
- GARMIN GXM™ 54 SIRIUSXM® WEATHER ANTENNA
- AIRMAR B175M CHIRP THRU-HULL TRANSDUCER UPGRADE
- CONSOLE DRAPE - BLACK SUNBRELLA
- CUSTOM PAINTED COLOR ENGINE (TWINS)
- DARK HULL COLOR (BLACK/SHARK) UPGRADE
- EDSON 13" SS COMFORT GRIP STEERING WHEEL W/ POWERKNOB
- GULL WINGS
- HALF TOWER W/ SECOND STATION (REQ. JL AUDIO M6 UPGRADE)
- MOORING COVER - BLACK SUNBRELLA
- ON-BOARD BATTERY CHARGING SYSTEM (3-BANK)
- RELEASE MARINE PACKAGE

Stereo Upgrade

- Garmin/Fusion RA770 Source Unit
- JL M6 Speakers
- JL 10" DSP Amplified Subwoofer
- JL DSP Amplifier

- SEAKEEPER 1 GYROSCOPIC STABILIZER
- SUN SHADE W/ POLES – FRONT & OR REAR
- SUNDECK / TABLE CUSHION
- TACO OUTRIGGERS - GS280
- TRANSHIELD SHIPPING COVER
- TROLLING MOTOR PLUG, HARNESS & ADAPTER
- YAMAHA HELM MASTER AUTO PILOT

Powder Coat Selection

- Black - White

Color Selection

- Explorer Blue
- Ice Blue
- Island Blue
- Sea Mist Green
- Silver Cloud
- SnowWhite



Features & Performance

Major Features

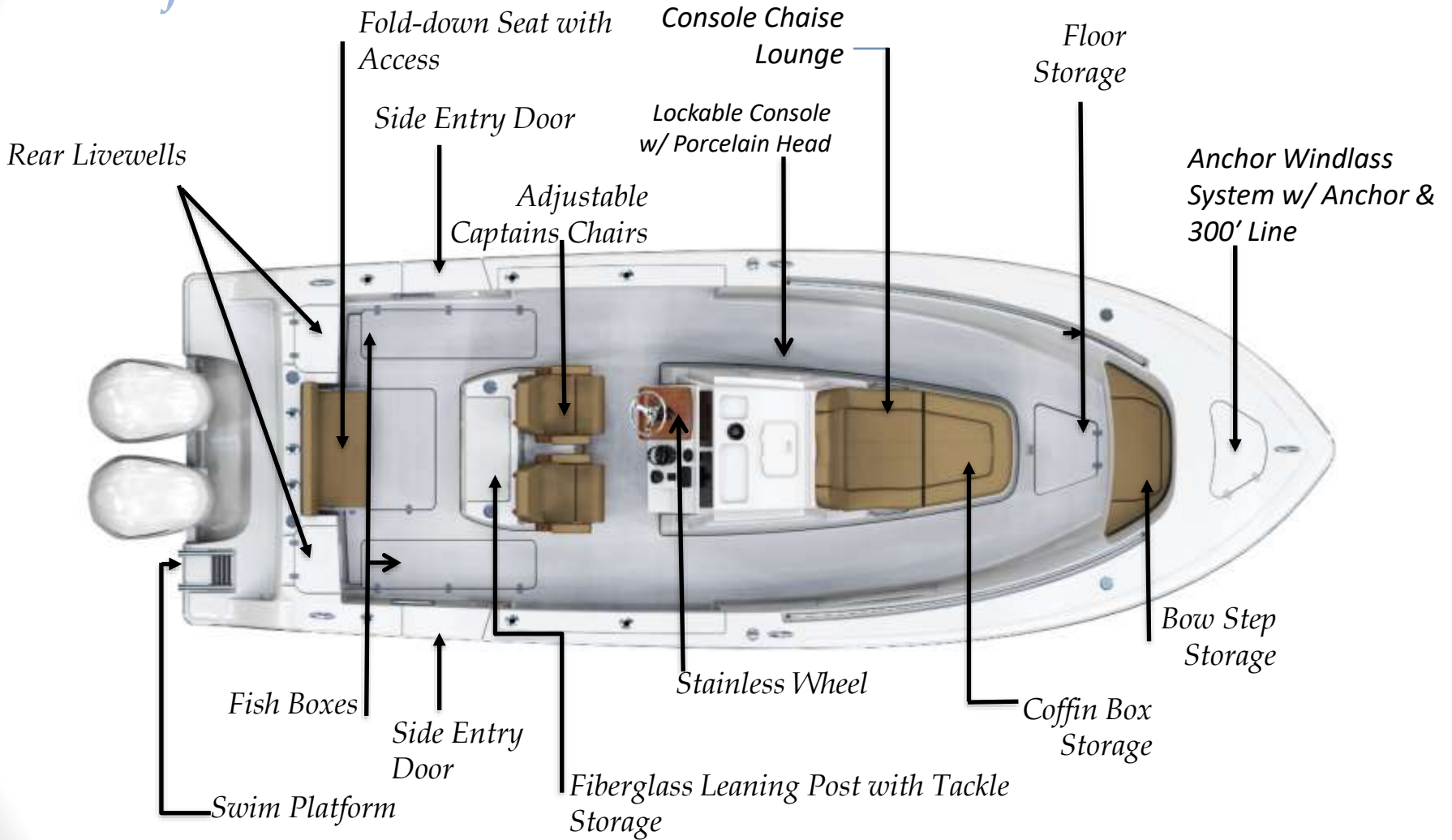

SPORTSMAN

Features & Performance



Twin Yamaha F200XCA



The lightest DOHC outboard in its class, this Inline 4 engine is the perfect, lightweight 200-hp solution for this size boat and features digital controls.

Digital Controls

Inline 4

ENGINE TYPE	Inline 4
DISPLACEMENT	2.8L
HORSEPOWER	200hp @ 5500 rpm
WEIGHT	489 lbs

NEW Twin Yamaha F300XSB



These trusty outboards are turning heads again, with a fresh new look and new, integrated digital electric steering — making them even more responsive.

Digital Controls

Integrated Steering

ENGINE TYPE	V6
DISPLACEMENT	4.2L
HORSEPOWER	300hp @ 5500 rpm
WEIGHT	588 lbs

SPORTSMAN



NMMA Certification

Sportsman Boats is certified by the National Marine Manufacturers Association (NMMA). NMMA certification not only meets the standards of the United States Coast Guard (USCG), but goes further to meet the standards set by the ABYC (American Boat and Yacht Counsel). All Sportsman models have been designed, constructed, and thoroughly tested to meet or exceed these standards. For more information about these standards, you may visit <http://www.nmma.org/certification/boats>.

Hull Identification Number & Registration

Sportsman has a permanent record of your boat. This record is documented during the manufacturing process. It is identified by its "Hull Identification Number" (HIN). **The HIN is a 12-digit code located on the starboard side of the transom, just under the Rub Rail.** When contacting your dealer concerning maintenance or warranties, please have your HIN and model number available. This information can be found on your copy of the warranty card. Federal and State laws require a power boat to be registered in the state where it is primarily used. Registration numbers and validation stickers must be displayed according to regulations. The registration certificate must be on board when boating. The boat serial number, or Hull Identification Number (HIN), is required on the registration form. The HIN should be included on all documents or any correspondence.



LIGHTING

Your Sportsman boat is equipped with navigation lights which comply with both Inland and International rules.

FIRE EXTINGUISHER

At least one Type-1 hand held portable fire extinguisher must be carried on board. For boats over 20' two are required. Check extinguisher regularly for charge status.

REQUIRED SAFETY EQUIPMENT

The US Coast Guard (USCG) requires that every boat have specific equipment on board. Check with local regulations on mandatory equipment apart from the list of Coast Guard requirements.

SOUND SIGNALING DEVICES

Your Sportsman boat is equipped with an electric horn which meets the USCG requirements for a sound signal device.

PERSONAL FLOTATION DEVICE (PFD)

You must have a USCG approved personal flotation device of Type I, II, or III aboard for each passenger, in addition to one Type IV throw able PFD. **Always wear a PFD when boating.** In some states, children are required to wear a PFD at all times. Check your local regulations.

VISUAL DISTRESS SIGNALS

USCG approved visual distress signals are required for day and night use when operating on US waters. Approved signals include flares, orange smoke, an orange distress flag, or an electric distress light.



Being on the water is a great experience, but it can become a bad experience very quickly if safety and maintenance instructions of your boat are not followed. Therefore, warnings and notices have been included in order to help you operate and maintain your boat safely. They are defined as follows:

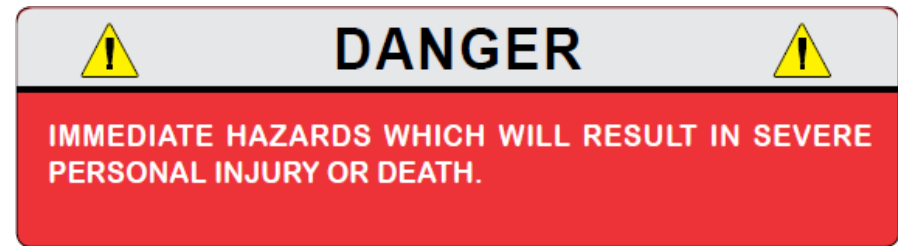
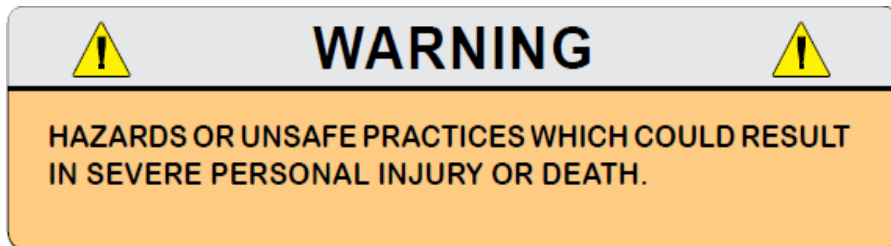

Please become familiar with the location and content of the Caution, Warning, and Danger Labels found on your boat.

Boating Safety



Your Owner's Manual was written to include safety instructions to ensure safe operations. Safety alert symbols are used to show potential personal injury hazards.

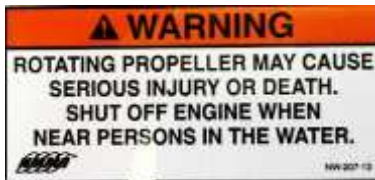
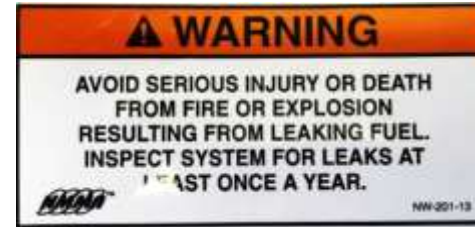

Every precaution has been taken to reduce the risks associated with death, possible injury and damage from fire or explosion. You must also take your own necessary precautions and practice proper maintenance procedures in order to enjoy the optimal safe operation of your boat.

If your label is damaged. Please call Sportsman's parts department for replacement stickers.

Your boat produces carbon monoxide and uses flammable fuel. Carbon monoxide can cause brain damage or death. Carbon monoxide is colorless, odorless and extremely dangerous.

⚠ DANGER



Carbon monoxide (CO) can cause brain damage or death.

Engine and generator exhaust contains odorless and colorless carbon monoxide gas.

Carbon monoxide will be around the back of the boat when engines or generators are running.

Move to fresh air, if you feel nausea, headache, dizziness, or drowsiness.

NW-206-13

⚠ WARNING



Carbon monoxide (CO) can cause brain damage or death.

Engine and generator exhaust contains odorless and colorless carbon monoxide gas.

Signs of carbon monoxide poisoning include nausea, headache, dizziness, drowsiness and lack of consciousness.

Get fresh air if anyone shows signs of carbon monoxide poisoning.

See Owner's Manual for information regarding carbon monoxide poisoning.

Boating Safety Label Locations



⚠ WARNING
 ROTATING PROPELLER MAY CAUSE
 SERIOUS INJURY OR DEATH.
 DO NOT APPROACH OR USE
 LADDER WHEN ENGINE IS RUNNING.

**NMMA
 CERTIFIED**
YACHT CERTIFICATION
 DESIGN COMPLIANCE WITH NMMA REQUIREMENTS IN EFFECT
 ON THE DATE OF CERTIFICATION IS VERIFIED.
 MANUFACTURER RESPONSIBLE FOR QUALITY CONTROL.
 NATIONAL MARINE MANUFACTURERS ASSOCIATION
 THIS BOAT COMPLIES WITH U.S. COAST GUARD SAFETY
 STANDARDS IN EFFECT ON THE DATE OF CERTIFICATION.
 MEETS U.S. EVAP STANDARDS
 USING CERTIFIED COMPONENTS
 MANUFACTURER NAME, CITY, ST

**MEETS U.S. EPA EVAP
 STANDARDS USING
 CERTIFIED COMPONENTS**

Sportsman Boats Mfg. Summerville, SC

⚠ DANGER
 Carbon monoxide (CO) can cause brain damage
 or death.
 Engine and generator exhaust contains odorless
 and colorless carbon monoxide gas.
 Carbon monoxide will be around the back of the
 boat when engines or generators are running.
 Move to fresh air, if you feel nausea, headache,
 dizziness, or drowsiness.

⚠ WARNING
 Carbon monoxide (CO) can cause brain damage or death.
 Engine and generator exhaust contains odorless and colorless carbon monoxide gas.
 Signs of carbon monoxide poisoning include nausea, headache, dizziness, drowsiness
 and lack of consciousness.
 Get fresh air if anyone shows signs of carbon monoxide poisoning.
 See Owner's Manual for information regarding carbon monoxide poisoning.

⚠ WARNING
 CONTENTS CAN BE UNDER PRESSURE
 AVOID SERIOUS INJURY OR DEATH FROM
 FIRE OR EXPLOSION
 OPEN SLOWLY IN WELL VENTILATED AREA
 NO SMOKING OR OPEN FLAMES

⚠ WARNING
 AVOID SERIOUS INJURY OR DEATH
 FROM FIRE OR EXPLOSION
 RESULTING FROM LEAKING FUEL.
 INSPECT SYSTEM FOR LEAKS AT
 LEAST ONCE A YEAR.

⚠ WARNING
 ROTATING PROPELLER MAY CAUSE
 SERIOUS INJURY OR DEATH.
 SHUT OFF ENGINE WHEN
 NEAR PERSONS IN THE WATER.

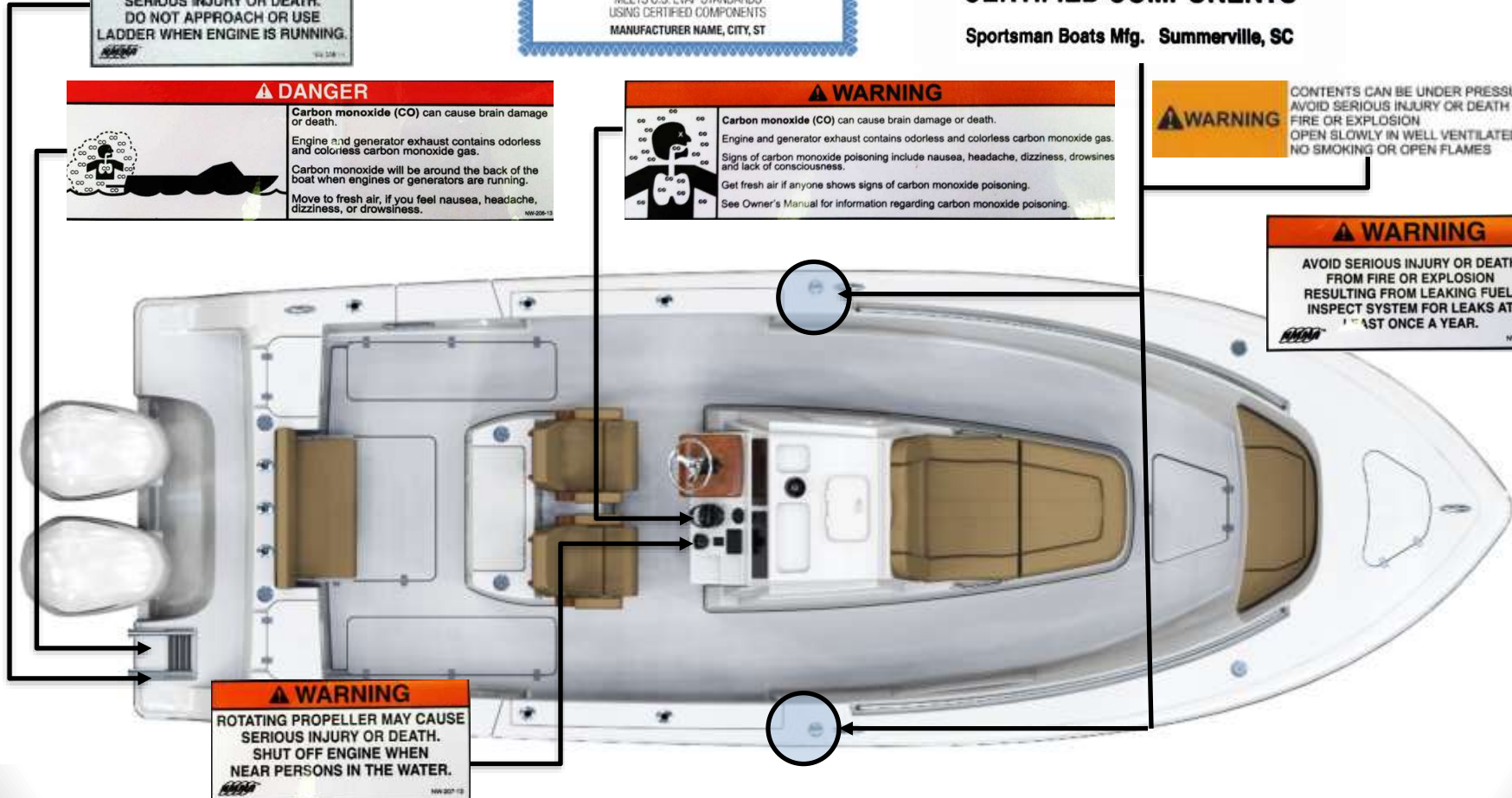

SPORTSMAN

Aquatic Invasive Species (AIS)

Aquatic invasive species (AIS) are plants and animals that occur in waters in which they are not native and whose introduction causes or is likely to cause economic or environmental damage or harm to human health. AIS have a negative impact on the waterway, its native species, and recreational and commercial uses of the waterway.

As responsible boaters and citizens, each boat owner should do their part to prevent the spread of these aquatic hitchhikers. In many cases, it is also required by law. Check local regulations for any waterway where you will boat.

After each boating trip, follow these three simple steps before you leave the water access to stop the spread of AIS: Clean, Drain, and Dry. This is the boater's way to help protect the environment from the damage that AIS can cause.

Clean

Inspect and remove all aquatic plants, animals, mud, and debris from the boat, engine, trailer, anchor, and any watersports equipment.

Rinse, scrub or wash, as appropriate, away from storm drains, ditches, or waterways.

Rinse watercraft, trailer, and equipment with hot water, when possible.

Flush motor according to owner's manual.

Drain

Completely drain all water from the boat and its compartments, including but not limited to the bilge, wells, lockers, ballast tanks or bags, bait containers, engines, and outdrives.

Dry

Allow the boat to completely dry before visiting any other bodies of water.

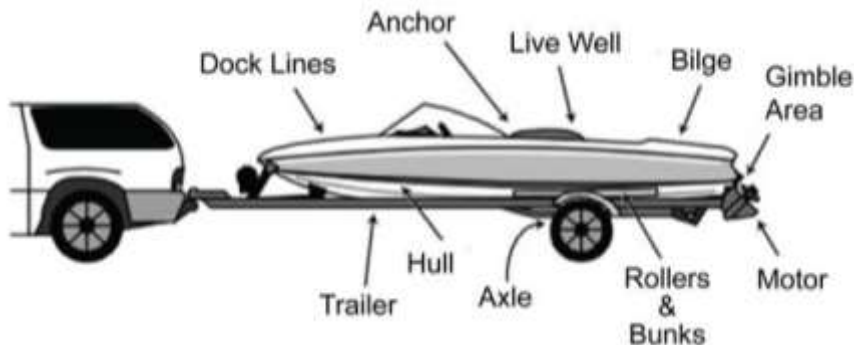

NOTE: Some localities may require inspection or decontamination before and/or after launching. Check state and local laws and regulations for requirements prior to traveling to go boating.



Electrical & Plumbing Systems



SportLink® **Electronics Integration System**

BATTERY SWITCHES

Access to the battery switches has never been easier. There is a switch for each engine and one for the house. The house isolates all of your electronics, lights, amps and pumps from your engine batteries. All batteries charge simultaneously when the motors are running.



SPORTSMAN

Electrical & Plumbing Systems



SportLink®

Electronics Integration System

GARMIN GPSMAP® 1243XSV TOUCH MFD 12"

The Garmin 1243 XSV is the 12.1" display with preloaded maps, easy to networks, and sharp design, the 1243 XSV is a great choice. The new improved display and visibility options along with the edge to edge glass makes it sit flush on the Sportsman center console.



SPORTSMAN

Electrical & Plumbing Systems

Garmin 12" Package

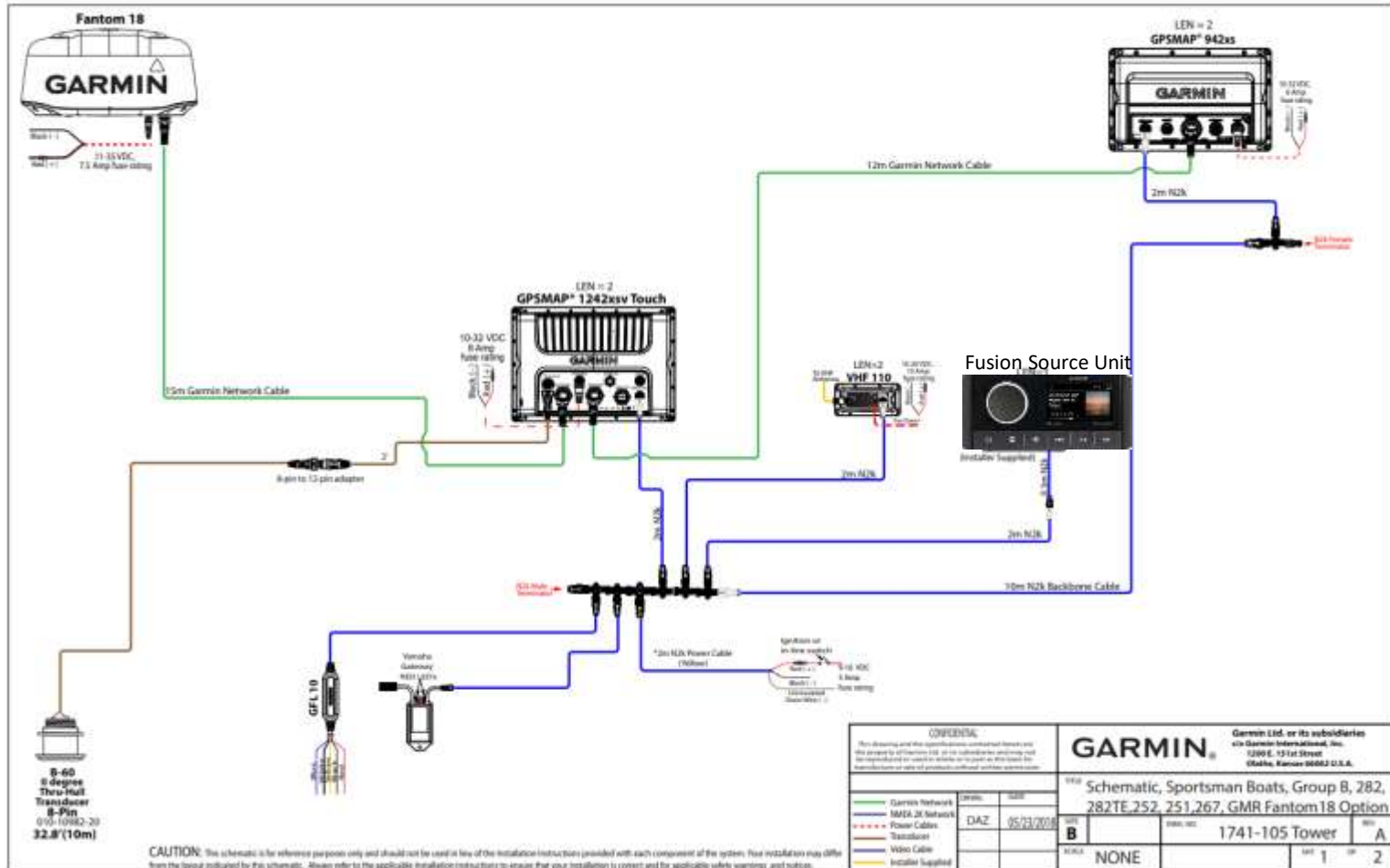

Electrical & Plumbing Systems

Digital Switching

SeaStar Maximus DCM Digital Switching System

Redefining Convenience & Innovation

The SeaStar Maximus DCM Digital Switching System eliminates the need to have physical switches on the dash. This not only cleans up the dash of switches but it add longevity to the electrical system of your boat. This is the way of the future and here at Sportsman Boats, we are leading the pack in innovation.

The system communicates through NMEA2000 to your Garmin MFD to add a screen that shows all of your 12v switches, doing away with the need to have physical toggle switches on the dash. You are able to customize the look and feel of the switches as well as create presets and modes with your favorite combination of lights. This type of flexibility is just not possible without digital switching.

To wrap it all up, it also includes a fob that allows you to operate the 8 most used functions on your boat from up to 100 feet away from your Sportsman Boat. This remote can even turn all power on or off on the vessel, redefining convenience and innovation.



Sportsman Custom Key Fob 8-Button Multi-Function Sportsman Remote



Hard-Top Lights

Operates the blue lights overhead on the Hard-Top.

Spreader Lights

Operates the bright white LED lights located at the front and back of the top.

Courtesy Lights

Operates the blue ambient lighting located throughout the cockpit.

Underwater Lights

Operates the blue underwater lights.

Freshwater Pump

Operates the freshwater pump.

Raw Water Pump

Operates the raw water pump.

Power Button

Operates all of the power to the boat. This button is very similar to the main battery switch, it will interrupt all power to the boat.

Navigation Lights

Operates the red and green navigation lights built into the rubrail at the bow.

Electrical & Plumbing Systems



Maximus DCM

The Brain Powering The Digital Switching

At the heart of the system is the Maximus DCM. The module is mounted inside the console behind your electronics and provides a single source of power and fuses for all 12v accessories on the boat. One of the key features of the unit is the ease of being able to bypass the system and physically turn on any of the ports. The unit ships with all of the fuses in the normal position. Any of the fuses can be moved to the bypass position (as shown in the diagram) to override the system.

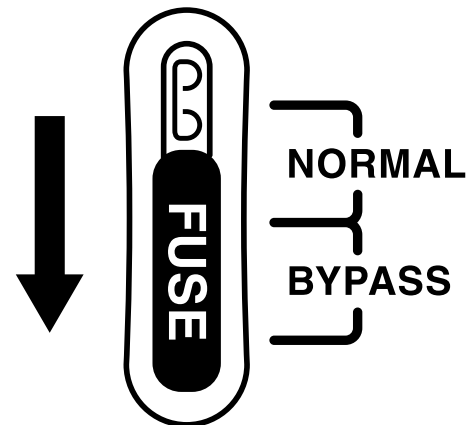

SPORTSMAN



Electrical & Plumbing Systems

Yamaha Digital Electric Steering

INCLUDED AS A STANDARD FEATURE ON THIS MODEL
Yamaha's DES (Digital Electric Steering) is the electronically controlled steering system with two different forms; Bolt-on and Built-in. Unlike aftermarket steering system, it is digitally connected from the helm to the engine, requiring no external pumps or steering fluid. It offers stable and assured steering and also steering setting can be changed depending on various boating situation. This system is commonly known as "Level 2" under Yamaha's Helm Master EX System.



SPORTSMAN

Electrical & Plumbing Systems

Lights

The *NAV/ANC Switch* is a 3-position switch on the console that controls the running lights.

- **NAV** position will turn on the red and green navigation lights and the white all-round light for night driving.
- **ANC** turns on the all-round light only for night anchoring. Do not operate the boat in anchor position.
- Off is in the center position.

Sidelights: The Open 282TE has navigational lights installed on the T-Top (see figure to the right). A green light is located on the starboard (right) side and a red light on the port (left) side of the vessel. Each shows an unbroken light over an arc of the horizon of 112.5 degrees and is fixed to show from ahead to just behind the beams of the vessel on its respective side.

All-round/Anchor Light: This is a white light placed over the highest unobstructed point of the vessel, showing an unbroken light over an arc of the horizon of 360°
See the figure to the right for location.

Recreational boats are required to display navigation lights between sunset and sunrise and other periods of reduced visibility (fog, rain, haze, etc.) Navigation lights are intended to keep other vessels informed of your presence and course. Your boat is equipped with the navigation lights required by the U.S. Coast Guard at the time of manufacture. It is up to you to make sure they are visible, operational and turned on.

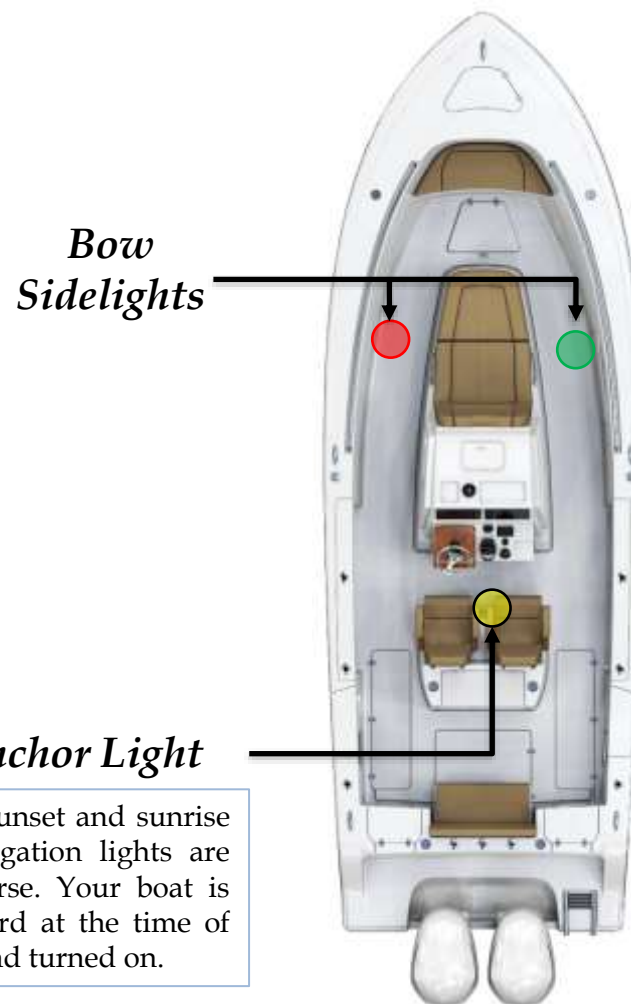

Electrical & Plumbing Systems

Stereo

Your boat is equipped a Fusion RA670 source unit and 10 standard JL Audio M6 white grille speakers. 6 are in the T-Top, 4 more speakers located around the cockpit. A remote controller in the bow area. Also comes with JL AUDIO MVI AMPS.

Your boat has a Fibergalss T-Top, is standard with 8 JL Audio speakers. These four speakers will be located on the T-Top underside fore and aft.

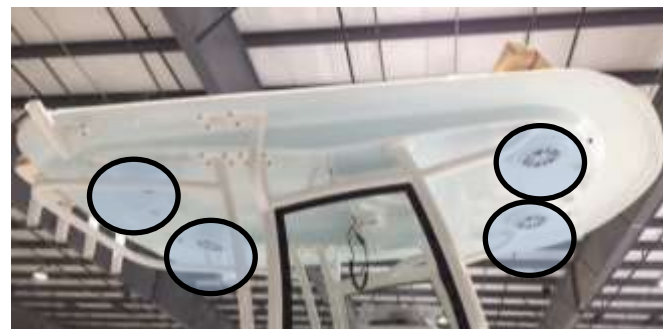

Speakers

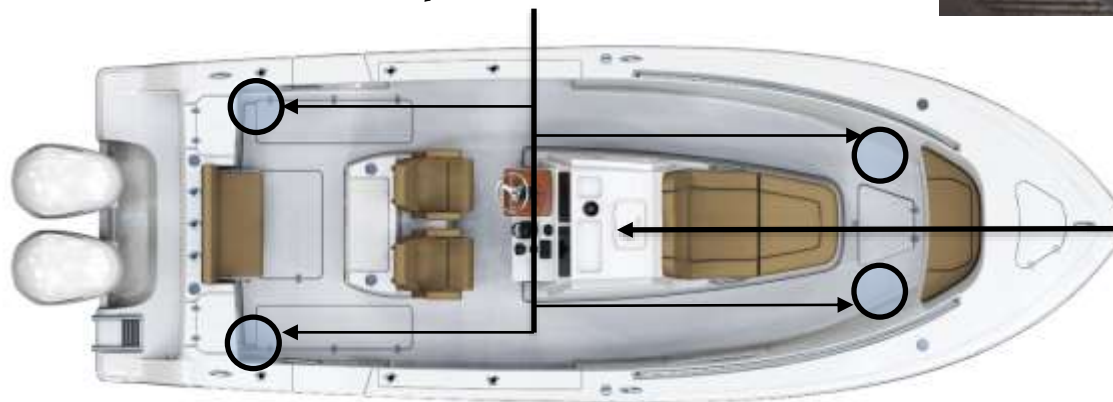

8 Channel Amplifier



Electrical & Plumbing Systems



JL AUDIO.
MARINE



2022 Sportsman 322/302 282/282TE
Audio System Wiring Diagram
Page 1 of 3

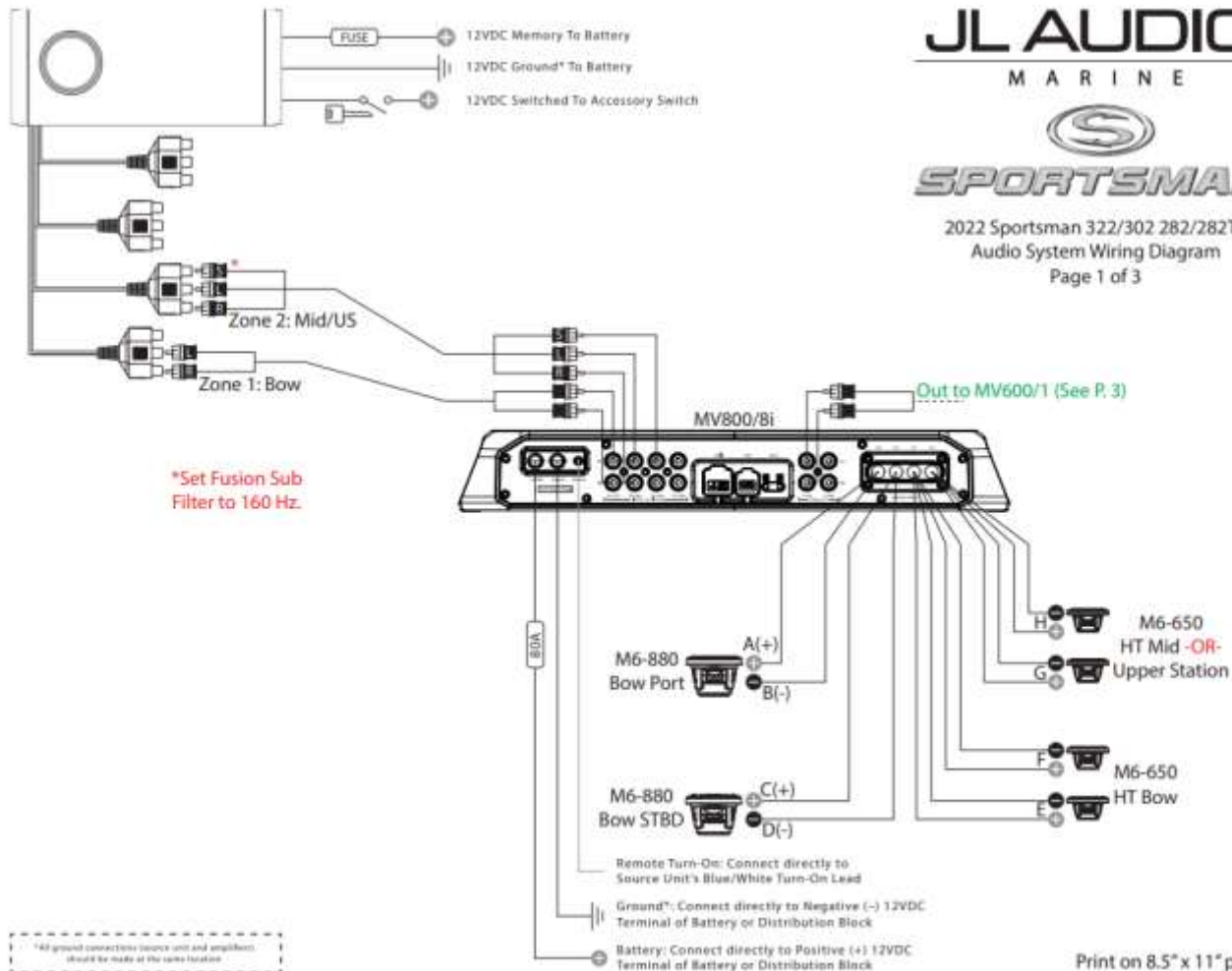

SPORTSMAN

Electrical & Plumbing Systems



2022 Sportsman 322/302 282/282TE
Audio System Wiring Diagram
Page 2 of 3



2022 Sportsman 322/302 282/282TE
Audio System Wiring Diagram
Page 3 of 3

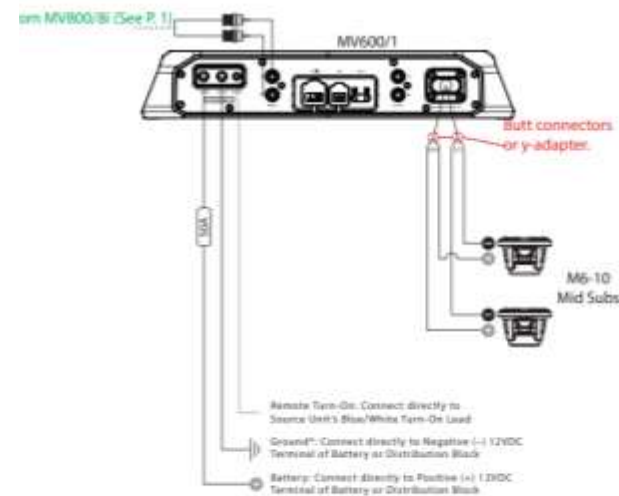
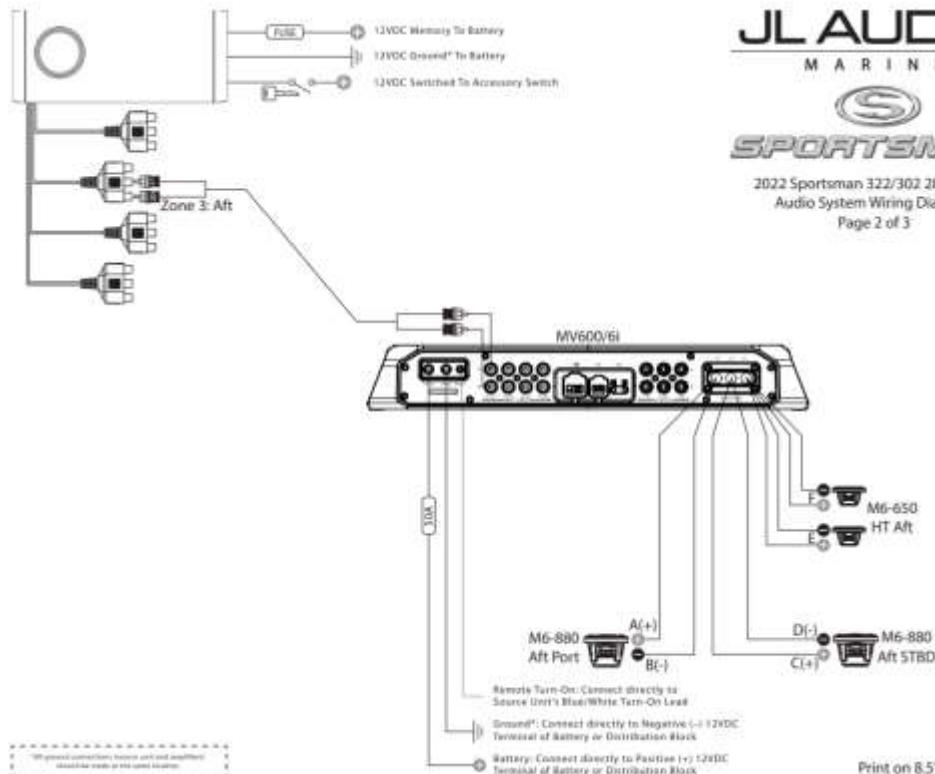

SPORTSMAN



Electrical & Plumbing Systems

Stereo 8 & 6 Channel DSP Amps



The NexD2™ full-range technology in this amplifier is DSP-controlled and features a reduced loop area design utilizing DirectFET™ outputs for outstanding fidelity, very low noise and exceptional efficiency. The amplifier chassis is ultra-compact, with all connections on one side, to greatly simplify installation into tight spaces.

Instead of traditional control knobs and switches, all amplifier adjustments and DSP functionality are configured via a compatible external device (PC, Tablet or Smartphone), with the appropriate JL Audio TüN™ Software application installed.

SPORTSMAN

Electrical & Plumbing Systems

Trim Tabs

Your Open 282 TE has trim tabs installed as a standard feature. They are attached to the bottom edge of the transom, as shown in the image below. When the trim tabs control at the helm (pictured to the right) is pressed, the trim tabs automatically move into position. The force of passing water on these tabs results in upward pressure at the transom, which will lower the bow. This helps to improve the performance of the boat in a wide range of weight, weather, and water conditions. The LEDs on the control panel indicate the position of the tabs. If all are lit up, that tab is all the way down. The port and starboard tabs may be operated independently if necessary. To lower the starboard bow, lower the starboard tab. To lower the port bow, lower the port tab.



Control Panel



Trim Tab

Electrical & Plumbing Systems

Trim Tabs

If you keep your boat in a wet slip/marina environment. Here is a list of different anodes recommended for various water types to prolong the life and shine of your stainless steel tab. Never use a wire brush to clean your tab

Zinc Alloy Anodes = Salt water only

Not recommended for use in fresh water
Alloy is manufactured to meet or exceed US Military Specification (MIL-A-18001K)

Aluminum Alloy Anodes = Salt or Brackish water

Not recommended for use in fresh water
Proven to last longer than zinc due to increased capacity
Alloy is manufactured to meet or exceed US Military Specification (MIL-A-24779(SH))

Magnesium Alloy Anodes = Fresh water only

Not recommended for use in salt or brackish water



Trim Tab

Electrical & Plumbing Systems

Bilge Pumps

Two small bilge pumps are located on the hull bottom at the stern of your boat. Water is pumped out of thru-hull fittings located on the port and starboard sides of the boat near the transom. The pumps may be accessed by removing the aft seat and door, in the area shown to the right. You may turn your bilge pumps on manually by flipping on a bilge switch located on the switch panel at the helm. Additionally, the bilge pump utilizes a float as an automated switch to turn it on automatically if necessary when the boat is unattended. The bilge pumps are designed to remove excess water **only**, and they are **not** intended to stop or prevent rapid accumulation of on-board water due to rough weather, hull damage, or any other unsafe navigational conditions.



The rear seat easily detaches to allow easy access to the bilge area at the stern.



Bilge Pumps

Drain Outlets



Electrical & Plumbing Systems

Fish Boxes

The Sportsman 282 TE Open features 2 fish boxes with macerators. The two fish boxes are located on each side of the leaning post; their macerators are inside the bilge area mounted to the side of the stringer. To operate the macerators, flip on the switch on the dash "PORT FISHBOX & STBD FISHBOX." This will empty the fish box with a dual-cut blade design, which allows for thoroughly ground waste. The macerator will not process hard objects, such as bones and rags. The maximum flow rate is approximately 13 gallons per minute. The macerators discharge via a thru hull fitting on the port side mid-ship of the hull.

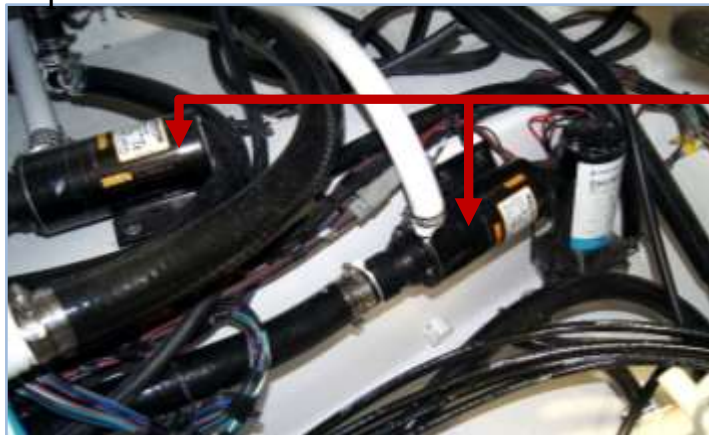

Macerators

Fish Box

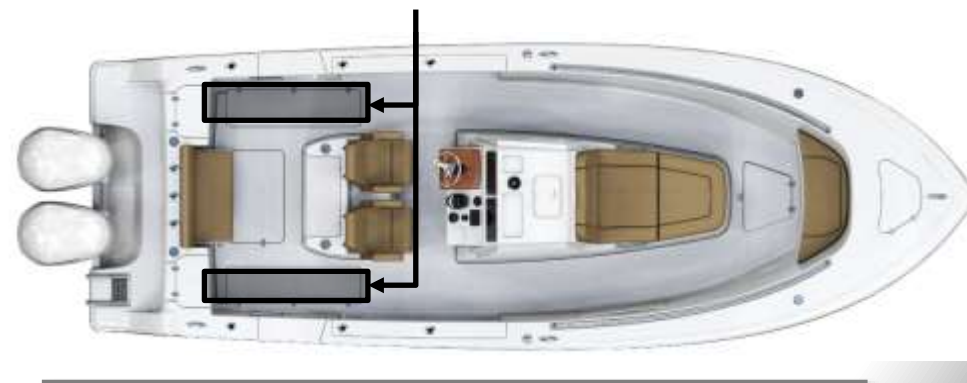

SPORTSMAN

Electrical & Plumbing Systems



TWIN PRESSURIZED 30-GALLON AQUARIUM LIVEWELLS

The Sportsman Open 282TE Deep twin aquarium 30-gallon insulated pressurized livewells with glass that allows you to keep an eye on your bait. It can also double as a cooler for drinks and food. Between both sides of the fold-out seat at the stern of the boat. For easy access to the pumps and plumbing systems, open the total access hatch forward of the transom. The livewell pumps are located on either side the bilge pumps in the hull of the boat, and the livewell fill hoses are connected to the top of the pumps. To operate the livewells, open the pump valve in the bilge, turn on the livewell switch at the helm, and turn the fill valve in the livewell to "open." The switches labeled "Livewell 1" and "Livewell 2" each fill their respective livewells. Both livewells are equipped with overflow drains so water cannot exceed a certain level and overflow. These overflow drains are connected to the main drain lines at 'T' joints, which empty out an outlet drain at the stern of the boat. Additionally, the livewells have LED lighting installed. To illuminate the livewell, turn on the switch at the helm.



*Pumps To
Fill Valves*



SPORTSMAN

Electrical & Plumbing Systems

Raw Water Wash-down

Your Open 282 TE has the raw water wash-down installed as a standard feature. Rinsing your boat immediately after use with a powerful water jet helps to maintain the boat's condition and value. This system supplies water via a hose connected to bottom of the same pump that supplies water to your livewells with a shut off valve in the bilge area at the total access hatch. To operate the wash-down system, start by opening the valve mentioned above. Then turn on the switch labeled "RAW WATER" on the switch panel on the screen. The wash-down outlet is found on the starboard side of the boat under the gunwale. See the figures here for important feature locations for the raw water wash-down system.



Shut Off Valve

Supply Hose



Outlet

Electrical & Plumbing Systems

Fresh Water Wash-down

Your Open 282 TE has the freshwater wash-down installed as a standard feature. The freshwater fill fitting is located near the motorwell. **Do not leave the tank full if your boat will be left unattended for an extended period of time;** pump the tank dry to avoid stagnant water in the tank if necessary. It is also important to periodically inspect and clean the filter, which is located on the pump. To operate this system, turn on the switch labeled "FRESH WATER" on the screen. This will pressurize the system for use. When the tank is empty or the boat is not in use, ensure that this switch is in the off position.



Outlet



Fill

Electrical & Plumbing Systems



Porcelain Head with Overboard Discharge or Pump Out:

The Quiet-Flush Toilet provides a quiet operation, with user control of the flush. A single large push button switch provides a simple flush mode by activating both the rinse water supply and the macerator discharge pump simultaneously. An additional rocker switch offers independent control of the rinse water supply and discharge pump separately so the bowl water level can be raised and lowered by the user. The rinse water is supplied from the 30 gallon water tank in the starboard stern of the boat. Your waste tank can be emptied two ways.

Removal from the waste deck fill at a shoreside pump-out facility.

Or: Turn on the OVBD Discharge switch at your helm to activates your macerator. Your waste will exit the boat at a through hull fitting on the starboard side mid-ship of the hull.



SPORTSMAN

Windless System

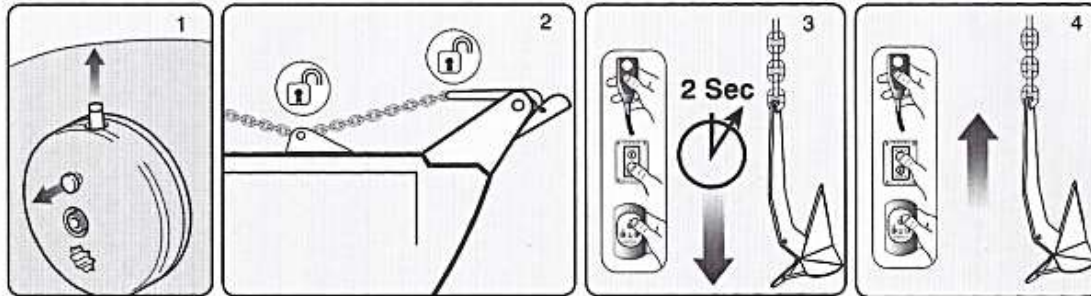

To release anchor:

1. Check unit is not in manual mode and plunger is disengaged/up position.
2. Release any anchor locks.
3. Engage the circuit breaker/isolator.

When releasing the anchor, press DOWN button for 2 seconds until the anchor is under freefall. If the clutch was left in a locked position the anchor will move almost immediately, if unlocked it could take several seconds to fully re-engage the internal clutch.

NOTE: Pressing the DOWN button for over 5 seconds will result in a longer clutch re-engagement time during the next UP command).

If using a rope/chain rode, motor astern to create the desired scope. Once scope has been created press the UP button continuously until freefall stops. It normally takes several seconds to fully re-engage the internal clutch mechanism, locking the windlass.

NOTE: Failure to lock the windlass clutch could result in rope/chain creeping out.

To retrieve anchor:

4. Press the UP button continuously to retrieve the anchor.



SPORTSMAN

Fuel System

Fuel Tank

The Sportsman Open 302 comes with a fuel tank installed (230 approximate usable gallon capacity). The gasoline fuel system consists of a fuel tank (located underneath the helm seat as shown in the figure), anti-siphon valve, engine fuel supply line, and 2 fill caps. Your boat contains a new EPA certified fuel system. The system prevents spit-back when filling the tanks and lowers the out-gassing emissions through a vent in the new designed fuel fill cap.

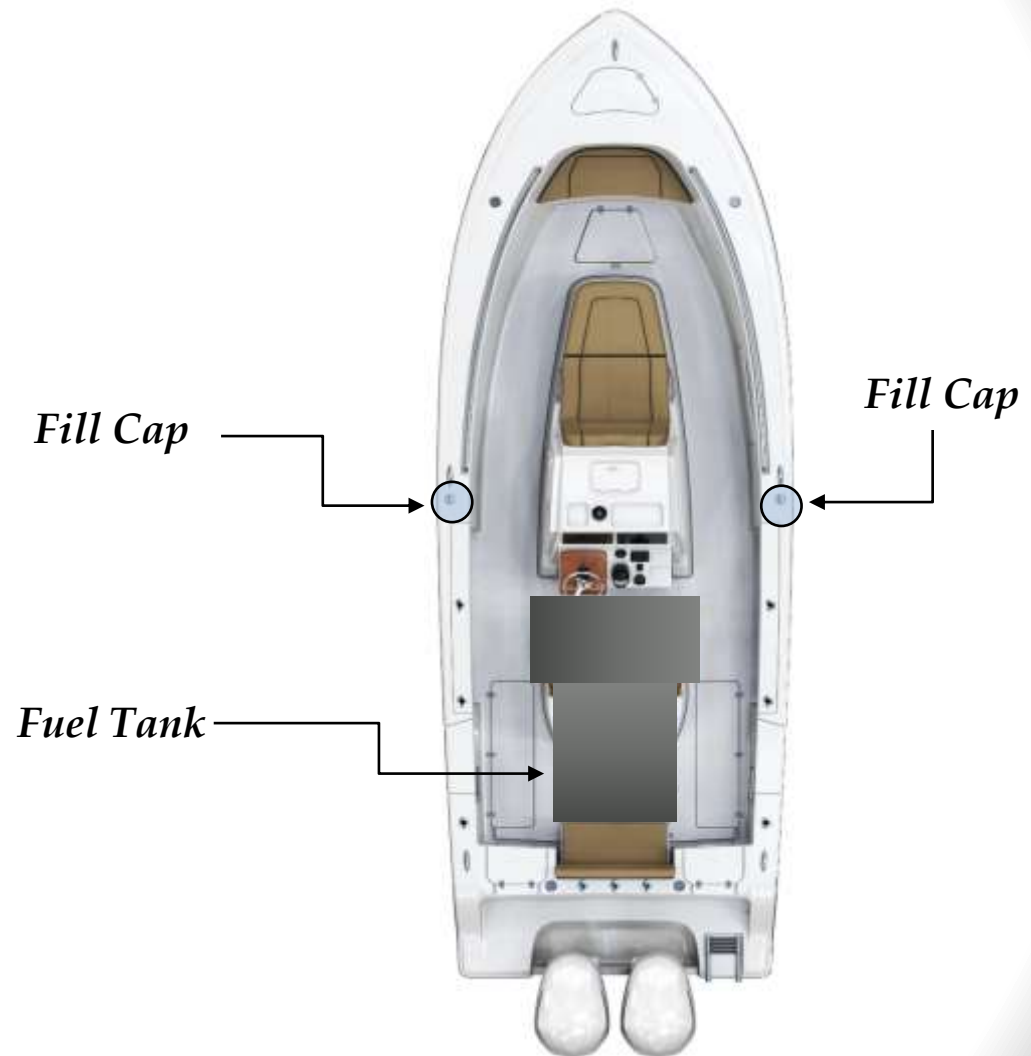

Fuel System

Diurnal Fuel System



BluSkies

EPA DIURNAL FUEL SYSTEMS

NOTE: Pressure may be present when opening your deck fill, regardless of system type.



Only open the fuel cap for refueling

Note: The first time fuel is introduced to a fuel tank, be aware of the interaction of cold raw fuel vapors replacing air, on occasion a vapor pressure can occur producing spit-back anomalies!

What is a diurnal fuel system?

Your new vessel is equipped with an Environmental Protection Agency (EPA) compliant diurnal fuel system, designed to reduce fuel emissions to atmosphere using criteria mandated by the EPA. Your vessels fuel tank is required and designed to have a positive pressure (>1PSI) as the sun heats the boat and the fuel in the tank expands or it may be equipped with a carbon canister to catch and contain fuel vapors

Your boats fuel tank also has valves installed inside that are designed to:

1. Produce a clean refueling shut off event
2. Create a 5% vapor space
3. Reduce the propensity of a refueling spit-back event.
4. Allow for appropriate venting when the vessel is stored or trailered. Your fuel cap also contains valves designed to retain fuel vapor (up to 1PSIG) and to allow make up air during engine operation

SPORTSMAN

Fuel System

Diurnal Fuel System (cont'd)



Vapor Space (Ullage) And Refueling Management

Another fuel system necessity to remain EPA compliant it is to keep elevated temperature gasoline from expanding into fuel system areas that are not low permeation rated or otherwise sensitive to raw fuel. A vapor (or ullage) space must be produced at the completion of the filling or refueling operation to ensure systems remain EPA compliant during the diurnal temperature cycle. To effectively manage this system function, BluSkies has created a series of valves that can mount to any marine fuel tank to achieve the appropriate fill level while maintaining ullage space of ~5%. Additionally these valves eliminate the propensity for refueling "spit-back" or tank "well-back", which is another requirement of the EPA regulation. BluSkies primary ullage valves replace the existing fill and vent locations, while additional grade or tip level valves can be added to any tank to meet American Boat And Yacht Council standards (H-24) which allows vapor venting for boats slanting or sloping when stored, moored, parked or trailered.

The final decision on which system type and ullage valve type and placement that is best for your application should be based on application specific factors such as type and configuration of fuel tank, how much room there on board is for added components, how are the boats likely to be used and stored etc. and of course cost.

Choose individual components to create a compliant system from the following pages or you can turn to our specialists for sound guidance and direction as you go through the process to choosing the appropriate system for your particular vessel application.

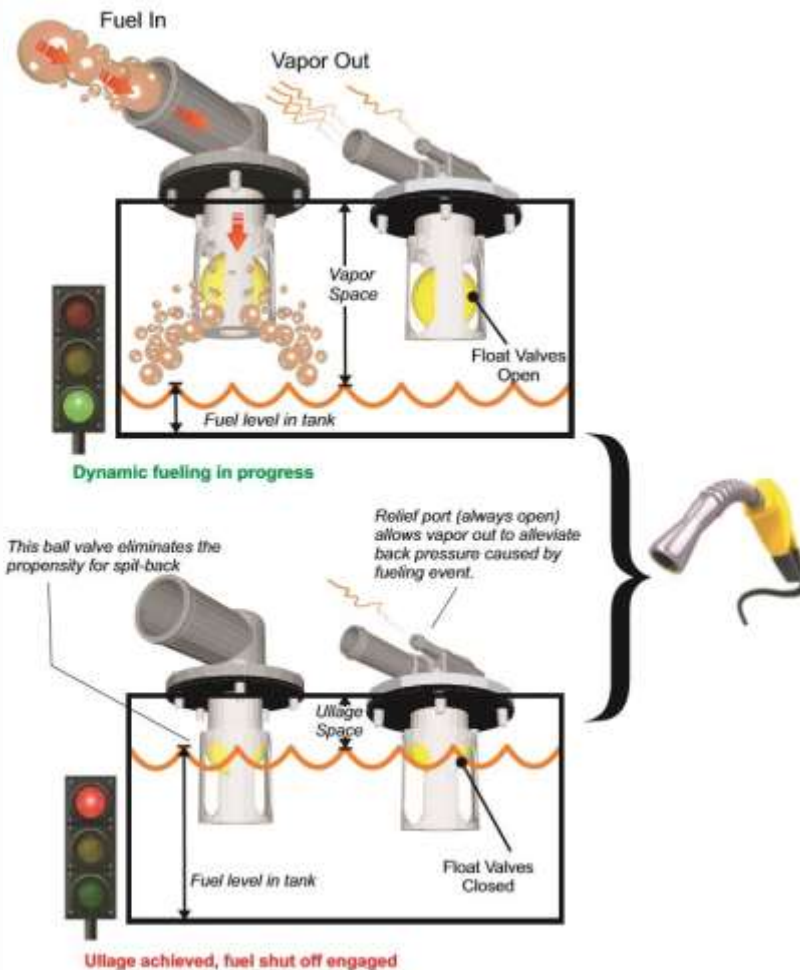

SPORTSMAN

Fuel System



Tank Vapor Space & Fluid Management

Ullage (Vapor Space) Level Attainment Spit-back/Well-back Control

This vent valve shuts off the refueling vapors and creates back pressure to lift the fill valve ball into place.

This fill valve ball is set lower than the vent valve ball but does not close until the refueling vapors are shut off by the vent valve.

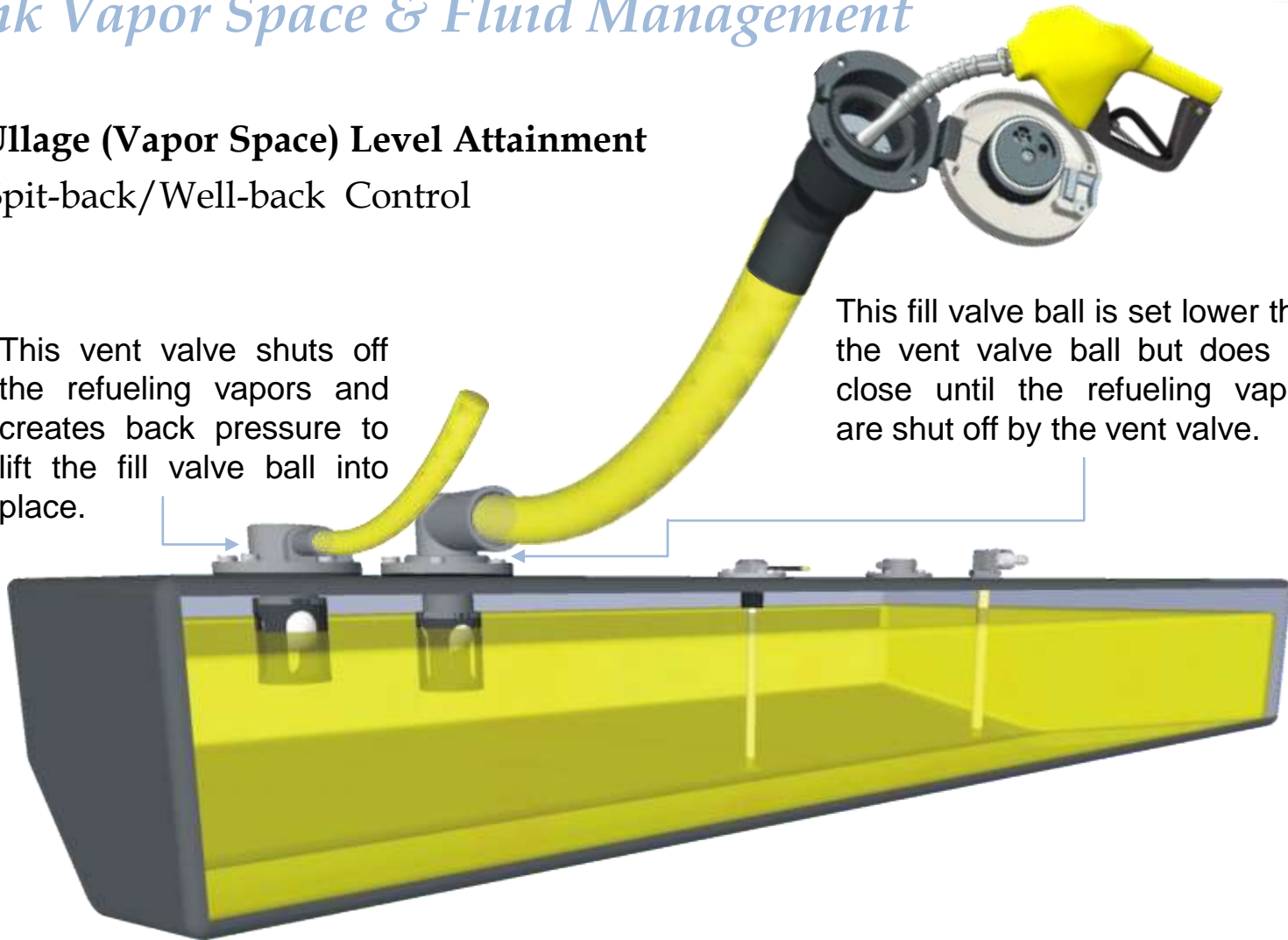

SPORTSMAN

Fuel System

Diurnal Fuel System: Refueling



Your fuel tank capacity will vary from the label or published capacity no less than 5% by law and up to 10% dependent upon the variation from static float due to equipment, occupants and gear etc. (Static Float = attitude in which your boat floats in calm water)

Fill your vessel fuel tank as normal, stop refueling after two (shut off) clicks of the fuel nozzle.

Topping off will over ride your fuel system design intent and could cause damage to your vessel due to overflow and will void any and all warranty claims related to fuel spillage.

BluSkies is expressly not responsible for any damage to your vessel subsequent to topping off.



**CONTENTS CAN BE UNDER PRESSURE
AVOID SERIOUS INJURY OR DEATH FROM
FIRE OR EXPLOSION
OPEN SLOWLY IN WELL VENTILATED AREA
NO SMOKING OR OPEN FLAMES**

It has been a common practice for many years to top off boats prior to storage or in preparation for a day on the water, however diurnal fuel systems are designed specifically to leave a space in your fuel tank to allow the fuel to expand during the heat of the day. GASOLINE EXPANDS 5%.

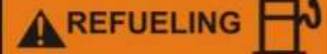

**GASOLINE CONTENTS UNDER
PRESSURE. FUEL SPRAY MAY
OCCUR.**

1. OPEN CAP SLOWLY
2. INSERT FUEL NOZZLE
3. BEGIN & CONTINUE FUELING UNTIL FUEL NOZZLE KICKS OFF
4. WAIT 10 SECONDS & CONTINUE FUELING UNTIL NOZZLE KICKS OFF A SECOND TIME
5. RETURN NOZZLE TO PUMP
6. DO NOT TOP OFF

Boating Navigation Rules

There are three main situations that you may encounter with other vessels which could lead to a collision unless the Steering Rules are followed:

- Meeting**: you are approaching another vessel head-on
- Crossing**: you are travelling across the path of another vessel
- Overtaking**: you are passing or being passed by another vessel

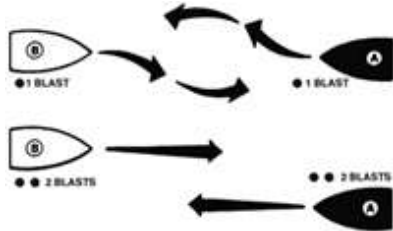

When Meeting Port-to-port: Continue on course. The same holds true for meeting starboard-to-starboard.

When Meeting Head On: As in a car, both stay to your right and as far apart as practical. Each boat should turn to starboard and pass port-to-port.

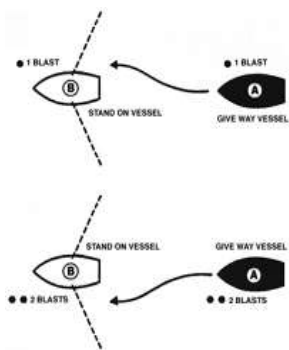

When Crossing: Every boat has a "Danger Zone" from straight in front (the bow) to past the middle of its right side. Like when meeting another car at a street intersection, the one on the right has the right of way. You must yield to boats in your Danger Zone. If you are the skipper of the Vessel A in the center of the diagram, you must keep out of the way of any boat that approaches you from any direction within the indicated Danger Zone, as you are the burdened craft. Likewise, boats approaching you from all other directions, except the meeting vessel, must keep clear of you.

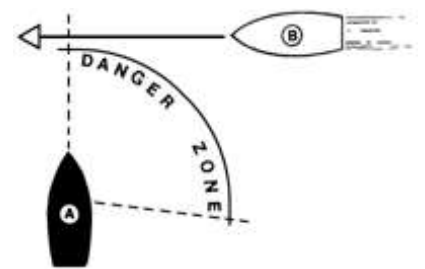

When Overtaking Another Boat: The boat being overtaken is the privileged vessel. Only after signaling and receiving an acknowledgment can the overtaking boat pass. (Use one blast to pass on the right, and two blasts to pass on the left.)

When Being Overtaken: Be ready for trouble when a power boat passes you in a narrow waterway. As the lead boat, which always has the right of way, stay on your side of the channel and maintain a steady speed so that the overtaking vessel can pass you safely. Use your radio to discuss this with the passing boat.



Product Changes

Sportsman is committed the development of our product line. As a result, equipment described in this manual may have changed or no longer may be available. All information, illustrations and specifications contained in this manual reflect the latest product information available at the time of publication. Sportsman reserves the right to make changes to its boats at any time, without notice. These changes include, but are not limited to: color options, materials, standard and optional equipment, specifications and model availability. If you have any questions about the equipment on your boat, please feel free to contact Sportsman.

Insurance

In most states, the boat owner is legally responsible for damages or injuries they or anyone else operating the boat causes. Some states have laws that require having at least minimum coverage. Before using your boat for the first time, you should contact your dealer, current insurance company, or state boating authority for information regarding insurance requirements in your area. Although it may not be required in your area, responsible boat owners carry liability and property damage for their boat. You should also protect the boat against physical damage and theft.

Service

All warranty work must be performed by an authorized Sportsman Dealer. If a problem is discovered upon taking delivery of, or develops during routine use of the boat that is related to faulty workmanship and/or materials, as stated in the warranty, you need to contact your Sportsman dealer to arrange for your boat to be repaired. **The boat owner is responsible for delivering the boat to the dealer for warranty service.** If you are not near your dealer or any other authorized Sportsman dealer, please contact Sportsman. Likewise, if the dealer fails to repair the problem, please notify Sportsman within 14 days of the work being completed. **Sportsman will not reimburse owners for unauthorized warranty work.**

Warranty Information



THERE IS NO IMPLIED WARRANTY FOR THIS PRODUCT. EXCEPT AS PROVIDED SPECIFICALLY HEREIN, THIS LIMITED WARRANTY IS IN LIEU OF, AND SPORTSMAN BOATS MANUFACTURING, INC. EXPRESSLY DISCLAIMS, ANY AND ALL OTHER WARRANTIES, EXPRESS, IMPLIED, OR STATUTORY, WHATSOEVER, INCLUDING, BUT NOT LIMITED TO, ANY IMPLIED WARRANTIES UNDER THE UNIFORM COMMERCIAL CODE, ANY IMPLIED WARRANTY OF MERCHANTABILITY, AND ANY IMPLIED WARRANTY FOR FITNESS FOR A PARTICULAR PURPOSE. SPORTSMAN BOATS MANUFACTURING, INC. MAKES NO OTHER EXPRESS WARRANTIES EXCEPT AS SET FORTH IN THIS LIMITED WARRANTY.

THIS LIMITED WARRANTY ALSO LIMITS AND ALTERS YOUR REMEDIES. THIS LIMITED WARRANTY SHALL BE THE SOLE AND EXCLUSIVE REMEDY OF ANY PERSON OR ENTITY FOR ANY CLAIM, WHETHER THAT CLAIM SOUNDS IN CONTRACT, TORT, OR IN ANY OTHER BASIS FOR RECOVERY. SPORTSMAN BOATS MANUFACTURING, INC. SHALL NOT BE LIABLE TO ANY PERSON OR ENTITY FOR ANY CONSEQUENTIAL, SPECIAL, OR INCIDENTAL DAMAGES, LOST PROFITS, INCONVENIENCE, OR ANY OTHER LOSS OR DAMAGE, EXCEPT AS PROVIDED IN THIS LIMITED WARRANTY.

SPORTSMAN BOATS LIMITED WARRANTY

Sportsman Boats Manufacturing, Inc. ("Sportsman") is pleased to provide to all owners of a Sportsman Boat (each a "Sportsman Boat") this Limited Warranty if the Sportsman Boat was purchased directly from any of the Sportsman authorized dealers and was operated under normal conditions, subject to all of the conditions and limitations provided herein.

Ten-Year Hull Limited Warranty. This Limited Warranty applies to any Structural Hull Defect (as that term is defined below) if such is due to a failure in material or workmanship and the same was reported to Sportsman according to the terms of this Limited Warranty within ten (10) years from the date of the sale to the original purchaser of the Sportsman Boat by a Sportsman authorized dealer. Sportsman, in its sole discretion, will either repair or replace the Hull. For purposes of this Limited Warranty, the term "Hull" shall mean the single fiberglass molded shell and integral structural components of a Sportsman Boat, and the term "Structural Hull Defect" shall mean a substantial defect in the Sportsman Boat's Hull that causes the boat to be unfit or unsafe for general use as a pleasure craft under normal operating conditions.

One-Year Nonstructural Limited Warranty. This Limited Warranty applies to any Nonstructural Defect (as that term is defined below) if such is due to a failure in material or workmanship and the same was reported to Sportsman according to the terms of this Limited Warranty within one (1) year from the date of the sale to the original purchaser of the Sportsman Boat by a Sportsman authorized dealer. Sportsman, in its sole discretion, will either repair or replace the defective component. For purposes of this Limited Warranty, the term "Nonstructural Defect" shall mean a substantial defect in a Sportsman Boat's components manufactured or installed by Sportsman (other than the Hull) that is not excluded in the Exclusions below.

Registration and Transfer of Limited Warranty. Each original purchaser of a Sportsman Boat shall complete and return the boat registration card provided by Sportsman within thirty (30) days of such owner's purchase of the boat in order to facilitate the processing of warranty claims and for manufacturer notification. Except where a Sportsman Boat has been salvaged and resold, or resold after a declaration of a total loss or a constructive total loss, the Ten-Year Hull Limited Warranty is transferable to a single subsequent owner (i.e., the second owner) of the Sportsman Boat, PROVIDED SUCH SUBSEQUENT OWNER COMPLETES AND SUBMITS TO SPORTSMAN WITHIN THIRTY (30) DAYS OF ACQUIRING THE SPORTSMAN BOAT A SPORTSMAN WARRANTY TRANSFER FORM (AVAILABLE FROM SPORTSMAN ON REQUEST) WITH (A) A LEGIBLE COPY OF THE BILL OF SALE, TITLE, OR REGISTRATION TO DEMONSTRATE OWNERSHIP OF THE BOAT AND (B) A CHECK OR MONEY ORDER PAYABLE TO SPORTSMAN FOR THE TRANSFER FEE IN EFFECT AT THE TIME OF THE TRANSFER.

Warranty and Services



SPORTSMAN BOATS LIMITED WARRANTY (cont'd)

EXCLUSIONS:

This limited Warranty does not apply to any boat that has been salvaged or declared a total loss or constructive total loss for any reason not specifically covered in this Limited Warranty. In addition, this Limited Warranty does not apply to the following "Exclusions:"

- 1) A Hull, component, or other product that has been repaired without authorization of Sportsman or that has been altered in any way that affects its use and operation;
- 2) Expenses related to inspection or warranty service for hauling out, transportation to and from any dealer or Sportsman factory, towing or storage changes, inconvenience or loss of time or income;
- 3) Engines, outdrives, controls, propellers, engine brackets, stereos, depth finder, GPS units, trolling motors, batteries, outriggers bases' and other equipment or accessories that are not manufactured by Sportsman, whether the same is or is not warranted by such other manufacturer;
- 4) Blistering, discoloring, cracking, or crazing of the Gelcoat finish or other surface finishes
- 5) Any Sportsman Boat initially sold at retail by a party other than an authorized Sportsman dealer;
- 6) Damage to, breakage of, or leakage around any windshields, hatches, or apertures;
- 7) Any canvas, zippers, vinyl, upholstery, plastic, or fabric components;
- 8) Discoloration, oxidation, bleeding, or corrosion of any stainless steel or other metal products
- 9) Any Hull, component, or product that has been subject to unreasonable use, tampering, abuse, mishandling, improper maintenance, negligence, improper trailing, alterations, or accidents;
- 10) Any boat, or component or part thereof, that has been used for Commercial Purpose, racing purposes, or has otherwise been operated contrary to any printed instruction provided by Sportsman or contrary to any applicable law (for purposes of this Limited Warranty, the term "**Commercial Purposes**" shall mean the usage of any boat more than fifty percent (50%) for revenue-producing or other business purposes);
- 11) A boat, or component or part thereof, that has been overpowered according to the maximum recommended engine horsepower specified on the capacity plate attached to the boat;
- 12) Machinery, equipment and accessories not installed by Sportsman;
- 13) Condensation of gauges;
- 14) The failure of any part, area, or component of the boat to be dry, whether or not the same was represented as "dry";
- 15) Any representation relating to the speed or weight of any part or component of the boat;
- 16) Normal wear and tear maintenance items, including, but not limited to, filters bulbs, batteries, bungees, anchor rope, trailer finishes, tires, brakes, bearing, and lights;
- 17) Any defect or repair requiring redesign of the boat, except pursuant to the recall provisions of the United States Federal Boat Safety Act of 1971 or the recall laws of the recall laws of any other foreign jurisdiction;
- 18) Dealer preparation, cleaning, and final adjustments and alignments in preparing the boat for delivery or commissioning; or
- 19) Any act of God or force majeure.

SPORTSMAN

Thank you for your purchase of your Sportsman Boat.

Sportsman Boats Manufacturing, Inc.
113 Sportsman Way · Summerville, South Carolina 29483
Telephone (843) 376-2628 · Fax (843) 376-2636

Email
sales@sportsmanboatsmfg.com

Website
www.sportsmanboatsmfg.com



SPORTSMAN