



**SPORTSMAN**

*Owner's Manual and  
Quick-Reference Guide  
2019*

# Table of Contents



<i>Topic</i>	<i>Page</i>
Introduction	3
Important Information	4
Specifications	5
Overall Dimensions & Terminology	6
Features & Performance	7
Certifications & Registrations	11
Boating Safety	12
Electrical & Plumbing Systems	17
Windless System	36
Fuel System	37
Boating Navigation Rules	42
Warranty & Services	43
Contact Information	46



# *Introduction*

## **WELCOME TO THE SPORTSMAN TEAM!**

Here at Sportsman Boats, we take great pride in producing the finest, most well designed saltwater fishing and pleasure boats on the market today. Our designs incorporate the most modern technology while applying good old “Common Sense” technology as well. From our advanced composite construction, ergonomic console designs, patented “Total Access” hatch, and superior ride and handling characteristics, we think you will agree that Sportsman is setting a new standard. Sportsman Boats builds the fastest growing line of family-friendly center console boats in-class, built with the latest designs, procedures and materials to give you and your family unparalleled performance with a dry, safe and comfortable ride

We do not take lightly the confidence you have placed in us with your decision to purchase your Sportsman boat. We will always strive to provide for you and your family the superior customer service you deserve. We hope that you enjoy your time out on the water as much as we enjoy building your Sportsman boat!

Safe Boating and Tight Lines,  
*Tommy Hancock*

# **SPORTSMAN**

---



# Important Information

<b>BOAT INFORMATION / SPECIFICATIONS</b>	
MODEL:	HULL SERIAL #:
PURCHASE DATE:	DELIVERED:
IGNITION KEY #:	REGISTRATION #:
DRAFT:	WEIGHT:
VERTICAL CLEARANCE:	
<b>ENGINE / PROPELLER INFORMATION</b>	
ENGINE MAKE:	MODEL:
ENGINE SERIAL #:	
PROPELLER MAKE:	# OF BLADES:
DIAMETER / PITCH:	MODEL:
PART #:	
<b>OPTIONAL EQUIPMENT / OPTION PACKAGES</b>	
<b>TRAILER INFORMATION</b>	
MAKE:	MODEL:
SERIAL #:	GVRM:
ADDITIONAL INFORMATION:	
DEALER	SPORTSMAN
NAME:	PHONE:
PHONE:	REPRESENTATIVE:
SALES PERSON:	ADDRESS:
SERVICE MANGER:	
ADDRESS:	

We recommend filling out the information in this table and keeping one copy of this page in your personal records and one copy with your owner's manual. This information will be important should you need to contact your dealer or Sportsman Boats Manufacturing for technical assistance and/or service.

# Specifications



Length Overall	28'2"
Beam	9'3"
Draft	19.75"
Deadrise at Transom	21°
Approximate Usable Fuel Capacity	195 gal.
Approximate Dry Weight	6700 lbs.
Maximum Engine Horse Power	600 HP (4 Stroke)

**SPORTSMAN**



# Overall Dimensions & Terminology

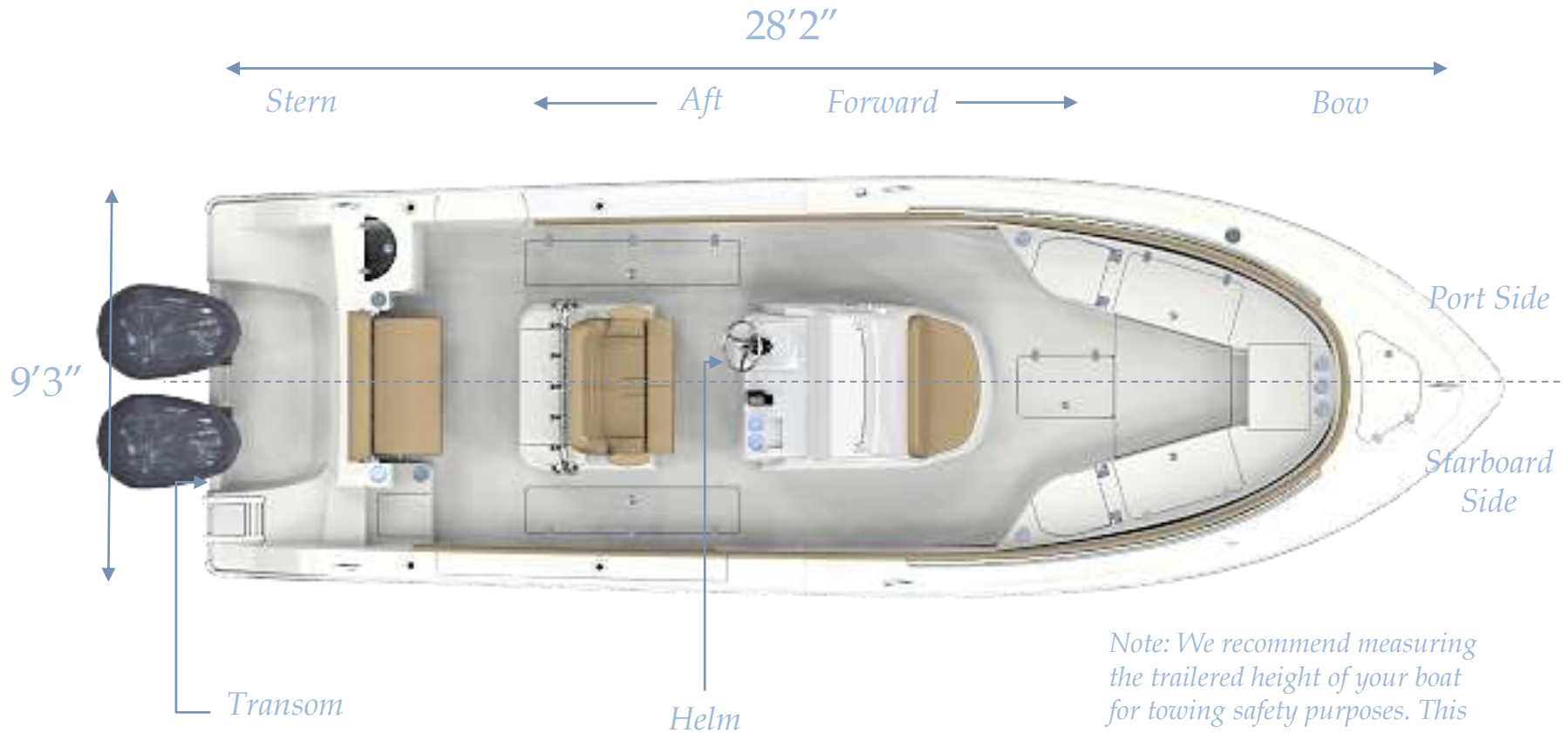

*Note: We recommend measuring the trailered height of your boat for towing safety purposes. This height may depend on the specific trailer being used.*

# SPORTSMAN

# Features & Performance



## Standard Features

- SportTech™ Advanced Fabrication Process
- SportLink™ Electronics Integration System
- Garmin GPSMAP® 1242xsv Touch MFD 12"
- Airmar B60 Thru-Hull Transducer
- Garmin VHF 110 Radio w/ Antenna
- JL Audio MediaMaster® MM50 Premium Marine Stereo
- (6) JL Audio MX650 White Sport Grille Speakers
- (2) Macerated In-Deck Fish Boxes
- (4) Flush Mount Gunwale Rod Holders
- 10-Year Hull Warranty
- 13 Gallon Freshwater Tank w/ Washdown
- 195 Gallon Fuel Tank w/ Fuel Level Sensor
- 30 Gallon Rear Livewell
- Adjustable Bow Backrest
- Advanced Fiberglass Stringer System (No Wood)
- Anchor Windlass System w/ Anchor & 300' Line
- Battery Switches & 3 Batteries
- Bow Cushion Set w/ Removable Filler Board
- Built-In Console Cooler Seat
- Built-In Swim Platform w/ 4 Step Ladder
- Compass
- Console Footrest with Pads
- Console Interior Liner
- Dash Panel Cover
- Dual Premium Seat on Fiberglass Leaning Post
- Electric Actuated Bow Sun Deck/Table
- Fiberglass Hard-Top w/ LED Lighting & Misters
- Fiberglass Leaning Post w/ Built-In Tackle Center & Sink
- Freshwater Washdown
- Grip Tex Yacht Style Non-Skid
- Helm Pad
- High Speed Livewell Pick Up
- Horn
- Insulated Bow Storage
- Integrated Tempered Glass Windshield
- Interior LED Lighting Package
- JL Audio Combo USB & 3.5 mm Audio Jack
- Light Hull Color
- Lockable Console Storage w/ Porcelain Head & Shower
- Matching Hard-Top Underside Color
- Optimus Electronic Power Steering w/ Tilt
- Port and Starboard Toe Rail
- Premium Marine Vinyl with Distressed Look
- Pull-Up Cleats
- Raw Water Washdown
- Rear Fold Down Seat w/ Access
- Recessed Bow Hand Rails
- Rub Rail Navigation Lights
- Self Bailing Cockpit
- Side Entry Door
- Stainless Steel Cup Holders - 11
- Stainless Steel Drain Covers
- Stainless Steel Propeller
- Stainless Steel Rub Rail
- Stainless Steel Steering Wheel w/ Knob
- Stainless Steel Switches
- Trim Tabs w/ LED Indicator
- Under Gunwale Rod Racks
- Underlid Gasket
- Underwater Lights

# SPORTSMAN

# Features & Performance

## Optional Features

- Second Garmin GPSMAP® 1242xsv Touch 12"
- Garmin GMR™ Fantom 18 Radome
- Garmin GMR™ Fantom 18 Radome (2nd Station)
- Garmin GMR™ 424 xHD2 Open Array
- Garmin Reactor™ 40 Autopilot
- Garmin GXM™ 53 SiriusXM® Weather Antenna
- JL Audio M6/MM100/Amps Package
- Airmar B175M CHIRP Thru-Hull Transducer Upgrade
- Custom Color Engine (Single)
- Custom Color Engine (Twins)
- Dark Hull Color(Black/St Blue) Upgrade
- Edson 13" SS Comfort Grip Steering Wheel w/ PowerKnob
- Fiberglass LP w/ Built-In 32 Gal Livewell
- Gull Wings
- Half Tower w/ Second Station

### *Stereo Upgrade*

- JL Speakers
- JL 10" Amplified Subwoofer
- JL Amplifier

### *Color Selection*

- Driftwood
- Ice Blue
- Island Blue
- Jet Black
- Sea Mist Green
- Silver Cloud
- Steel Blue
- White

### *Powder Coat Selection*

- Black - White



- Leaning Post Cover
- Mooring Cover (Sunbrella®)
- On-Board Battery Charging System
- Optimus 360 Joystick
- Powder Coating
- Release Marine Package
- Sun Shade w/Poles - Front
- Sun Shade w/Poles - Rear
- Sundeck / Table Cushion
- Taco Outriggers - GS280
- Transhield Shipping Cover
- Windshield Close Out

# SPORTSMAN



# Features & Performance

## Major Features

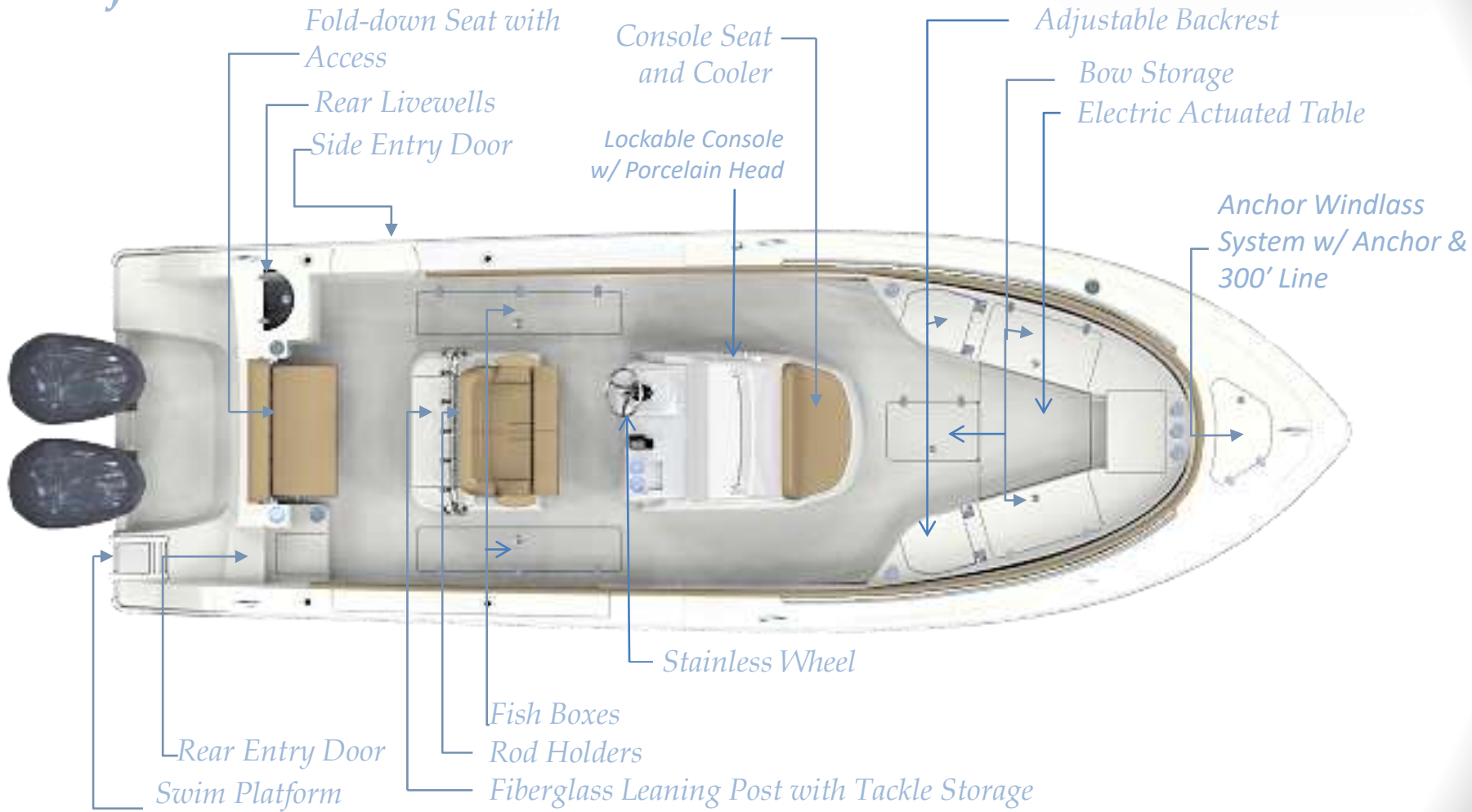

# SPORTSMAN

# Features & Performance

## Twin 200 HP

## Twin 300 HP



### PERFORMANCE BULLETIN



YAMAHA: PE\_EPT\_Open282\_1\_F200XCA\_2016-06-02\_DCC

Test Date 8/3/16



Boat Manufactured By:  
Sportsman Boats • 113 Isaac Way • Santeeville, SC 29485  
853-276-2626 • www.sportsmanboatsmfg.com

#### PERFORMANCE DATA

RPM	MPH	GPH	MPG
1000	5.5	1.5	3.63
1500	7.6	2.5	3.10
2000	9.5	4.0	2.38
2500	13.7	6.1	2.27
3000	19.7	8.0	2.46
3500	26.3	10.4	2.53
4000	31.8	13.5	2.34
4500	36.5	17.4	2.10
5000	41.0	23.0	1.78
5500	44.1	31.0	1.42
6000	46.3	39.8	1.24

Time to Plane: 3.33 (6-30 MPH)  
5.53

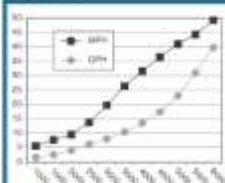

Test performed on velocity. Yamaha Registered Engines.

#### Sportsman® Open 282

Length	28' 2"
Beam	9' 3"
Dry Weight (Boat+Fuel)	6,700 lbs
Maximum HP	600
Fuel Capacity	195 gal
Weight as Tested	6,056 lbs

#### F200XCA / LF200XCA

Horsepower	200 HP
Induction	EFI
Displacement	2.8 L
Weight	480 lbs
Gear Ratio	1.88:1

#### ENGINE MOUNTING HEIGHT

Mounting Hole Position	#0
Verticals Plate Height	1" Above DOD INBOX

#### PROPELLERS

Series	Velocity®
Diameter/Pitch	16-1/4 x 17
Yamaha Part #	66F-45A72-10-00 / 68G-43B72-10-00
Propeller Material	Polished Stainless Steel

#### TEST CONDITIONS

Number of People	2
Air / Water Temperature (surface)	87 / 82° F
Elevation (at test area sea level)	260' LOASL
Wind Velocity	5-10 mph

Comments: Test weight includes 120 lbs of fuel, 2 batteries, safety and tow gear.

Notice to Customer: The information and specifications in this Performance Bulletin are approximate and subject to many different factors and variables. It is provided as a guideline only and should not be used as a representation of actual performance. Your boat's performance may be different than the information contained in this Performance Bulletin due to various factors, including your boat's actual weight, wind and wave conditions, temperature, humidity, elevation, bottom silt, load, engine efficiency, windward drag and/or load weight, and operator ability. Please confirm the specifications and performance data on your specific PowerTech component with your dealer prior to purchase. Please also keep in mind that the data contained in this Performance Bulletin may or may not have been performed using Yamaha PowerTech components. Yamaha reserves the right to change the specifications and performance data of this Performance Bulletin without notice. This document contains many of Yamaha's valuable trademarks. It may also contain trademarks belonging to other companies. Any references to other companies or their products are for identification purposes only and are not intended to be an endorsement.

For more information:  
Yamaha Motor Corporation, U.S.A.  
2700 Shelton, Marine Group  
1870 Chelton Road NW  
Fayetteville, GA 30214 • (800) 96-3666  
For other Performance Bulletins, visit www.yamaha-motor.com.

© 2016 Yamaha Motor Corporation, U.S.A. All rights reserved.

### PERFORMANCE BULLETIN



YAMAHA: PE\_EPT\_Open300\_1\_F300XCA\_2016-06-10\_DCC

Test Date 8/10/16



Boat Manufactured By:  
Sportsman Boats • 113 Isaac Way • Santeeville, SC 29485  
853-276-2626 • www.sportsmanboatsmfg.com

#### PERFORMANCE DATA

RPM	MPH	GPH	MPG
1000	8.1	2.6	2.97
1500	9.4	4.3	2.98
2000	11.5	7.1	1.61
2500	17.5	10.1	1.72
3000	26.1	12.7	2.21
3500	34.8	16.9	2.04
4000	40.3	22.4	1.80
4500	45.5	29.1	1.57
5000	50.9	37.8	1.35
5500	55.9	47.5	1.18
6000	59.8	57.9	1.12

Time to Plane: 3.30 (6-30 MPH)  
4.00

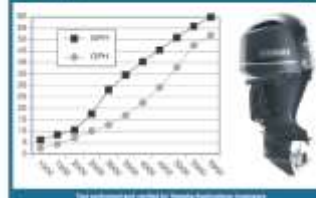

Test performed on velocity. Yamaha Registered Engines.

#### Sportsman® Open 282

Length	28' 2"
Beam	9' 3"
Dry Weight (Boat+Fuel)	6,700 lbs
Maximum HP	600
Fuel Capacity	195 gal
Weight as Tested	6,032 lbs

#### F300XCA / LF300XCA

Horsepower	300 HP
Induction	EFI
Displacement	4.3 L
Weight	562 lbs
Gear Ratio	1.75:1

#### ENGINE MOUNTING HEIGHT

Mounting Hole Position	#0
Verticals Plate Height	1" Above DOD INBOX

#### PROPELLERS

Series	Subsided Series 8™
Diameter/Pitch	15 x 20
Yamaha Part #	65E-43003-00-00 / 65F-43003-00-00
Propeller Material	Polished Stainless Steel

#### TEST CONDITIONS

Number of People	3
Air / Water Temperature (surface)	85 / 82° F
Elevation (at test area sea level)	Sea Level
Wind Velocity	5-10 mph

Comments: Test weight includes full tank of fuel, 2 batteries, safety and tow gear.

Notice to Customer: The information and specifications in this Performance Bulletin are approximate and subject to many different factors and variables. It is provided as a guideline only and should not be used as a representation of actual performance. Your boat's performance may be different than the information contained in this Performance Bulletin due to various factors, including your boat's actual weight, wind and wave conditions, temperature, humidity, elevation, bottom silt, load, engine efficiency, windward drag and/or load weight, and operator ability. Please confirm the specifications and performance data on your specific PowerTech component with your dealer prior to purchase. Please also keep in mind that the data contained in this Performance Bulletin may or may not have been performed using Yamaha PowerTech components. Yamaha reserves the right to change the specifications and performance data of this Performance Bulletin without notice. This document contains many of Yamaha's valuable trademarks. It may also contain trademarks belonging to other companies. Any references to other companies or their products are for identification purposes only and are not intended to be an endorsement.

For more information:  
Yamaha Motor Corporation, U.S.A.  
2700 Shelton, Marine Group  
1870 Chelton Road NW  
Fayetteville, GA 30214 • (800) 96-3666  
For other Performance Bulletins, visit www.yamaha-motor.com.

© 2016 Yamaha Motor Corporation, U.S.A. All rights reserved.

# SPORTSMAN

Note: These are posted on our website at  
<http://sportsmanboatsmfg.com/open-312-center-console/>



# Certifications & Registrations

## *NMMA Certification*

Sportsman Boats is certified by the National Marine Manufacturers Association (NMMA). NMMA certification not only meets the standards of the United States Coast Guard (USCG), but goes further to meet the standards set by the ABYC (American Boat and Yacht Counsel). All Sportsman models have been designed, constructed, and thoroughly tested to meet or exceed these standards. For more information about these standards, you may visit <http://www.nmma.org/certification/boats>.

## *Hull Identification Number & Registration*

Sportsman has a permanent record of your boat. This record is documented during the manufacturing process. It is identified by its “Hull Identification Number” (HIN). **The HIN is a 12-digit code located on the starboard side of the transom, just under the Rub Rail.** When contacting your dealer concerning maintenance or warranties, please have your HIN and model number available. This information can be found on your copy of the warranty card. Federal and State laws require a power boat to be registered in the state where it is primarily used. Registration numbers and validation stickers must be displayed according to regulations. The registration certificate must be on board when boating. The boat serial number, or Hull Identification Number (HIN), is required on the registration form. The HIN should be included on all documents or any correspondence.

# Boating Safety



## LIGHTING

Your Sportsman boat is equipped with navigation lights which comply with both Inland and International rules.

## FIRE EXTINGUISHER

At least one Type-1 hand held portable fire extinguisher must be carried on board. For boats over 20' two are required. Check extinguisher regularly for charge status.

## REQUIRED SAFETY EQUIPMENT

The US Coast Guard (USCG) requires that every boat have specific equipment on board. Check with local regulations on mandatory equipment apart from the list of Coast Guard requirements.

## SOUND SIGNALING DEVICES

Your Sportsman boat is equipped with an electric horn which meets the USCG requirements for a sound signal device.

## PERSONAL FLOTATION DEVICE (PFD)

You must have a USCG approved personal flotation device of Type I, II, or III aboard for each passenger, in addition to one Type IV throw able PFD. **Always wear a PFD when boating.** In some states, children are required to wear a PFD at all times. Check your local regulations.

## VISUAL DISTRESS SIGNALS

USCG approved visual distress signals are required for day and night use when operating on US waters. Approved signals include flares, orange smoke, an orange distress flag, or an electric distress light.

# Boating Safety



Being on the water is a great experience, but it can become a bad experience very quickly if safety and maintenance instructions of your boat are not followed. Therefore, warnings and notices have been included in order to help you operate and maintain your boat safely. They are defined as follows:

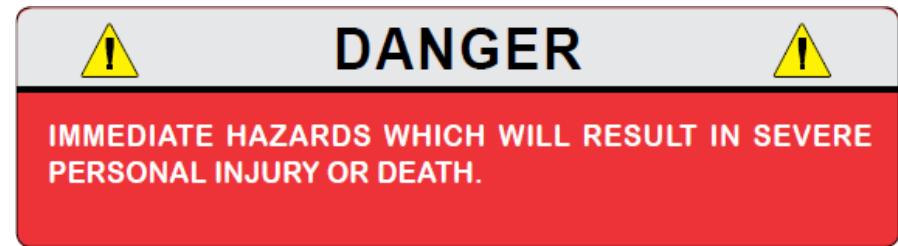
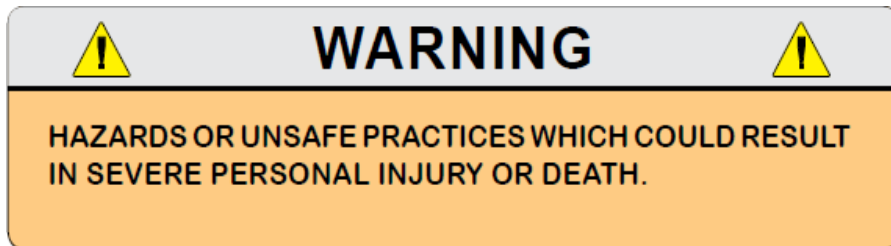

Please become familiar with the location and content of the Caution, Warning, and Danger Labels found on your boat.



# Boating Safety



Your Owner's Manual was written to include safety instructions to ensure safe operations. Safety alert symbols are used to show potential personal injury hazards.

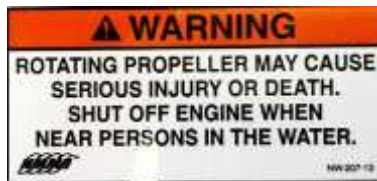
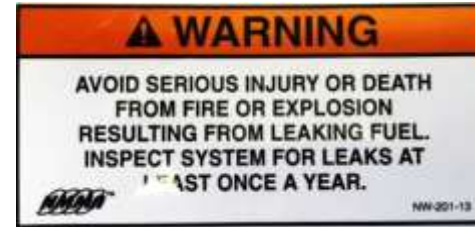

Every precaution has been taken to reduce the risks associated with death, possible injury and damage from fire or explosion. You must also take your own necessary precautions and practice proper maintenance procedures in order to enjoy the optimal safe operation of your boat.

*If your label is damaged. Please call Sportsman's parts department for replacement stickers.*

# Boating Safety



Your boat produces carbon monoxide and uses flammable fuel. Carbon monoxide can cause brain damage or death. Carbon monoxide is colorless, odorless and extremely dangerous.

**⚠ DANGER**



**Carbon monoxide (CO)** can cause brain damage or death.

Engine and generator exhaust contains odorless and colorless carbon monoxide gas.

Carbon monoxide will be around the back of the boat when engines or generators are running.

Move to fresh air, if you feel nausea, headache, dizziness, or drowsiness.

NW-206-13

**⚠ WARNING**

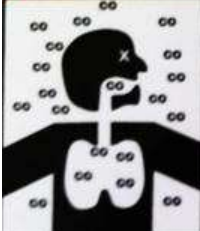

**Carbon monoxide (CO)** can cause brain damage or death.

Engine and generator exhaust contains odorless and colorless carbon monoxide gas.

Signs of carbon monoxide poisoning include nausea, headache, dizziness, drowsiness and lack of consciousness.

Get fresh air if anyone shows signs of carbon monoxide poisoning.

See Owner's Manual for information regarding carbon monoxide poisoning.

# SPORTSMAN

# Boating Safety Label Locations



**⚠ WARNING**  
 ROTATING PROPELLER MAY CAUSE  
 SERIOUS INJURY OR DEATH.  
 DO NOT APPROACH OR USE  
 LADDER WHEN ENGINE IS RUNNING.

**NMMA  
 CERTIFIED**  
**YACHT CERTIFICATION**  
 DESIGN COMPLIANCE WITH NMMA REQUIREMENTS IN EFFECT  
 ON THE DATE OF CERTIFICATION IS VERIFIED.  
 MANUFACTURER RESPONSIBLE FOR QUALITY CONTROL.  
 NATIONAL MARINE MANUFACTURERS ASSOCIATION  
 THIS BOAT COMPLIES WITH U.S. COAST GUARD SAFETY  
 STANDARDS IN EFFECT ON THE DATE OF CERTIFICATION  
 MEETS U.S. EVAP STANDARDS  
 USING CERTIFIED COMPONENTS  
 MANUFACTURER NAME, CITY, ST

**MEETS U.S. EPA EVAP  
 STANDARDS USING  
 CERTIFIED COMPONENTS**

**Sportsman Boats Mfg. Summerville, SC**

**⚠ DANGER**  
 Carbon monoxide (CO) can cause brain damage or death.  
 Engine and generator exhaust contains odorless and colorless carbon monoxide gas.  
 Carbon monoxide will be around the back of the boat when engines or generators are running.  
 Move to fresh air. If you feel nausea, headache, dizziness, or drowsiness.

**⚠ WARNING**  
 Carbon monoxide (CO) can cause brain damage or death.  
 Engine and generator exhaust contains odorless and colorless carbon monoxide gas.  
 Signs of carbon monoxide poisoning include nausea, headache, dizziness, drowsiness and lack of consciousness.  
 Get fresh air if anyone shows signs of carbon monoxide poisoning.  
 See Owner's Manual for information regarding carbon monoxide poisoning.

**⚠ WARNING**  
 CONTENTS CAN BE UNDER PRESSURE  
 AVOID SERIOUS INJURY OR DEATH FROM  
 FIRE OR EXPLOSION  
 OPEN SLOWLY IN WELL VENTILATED AREA  
 NO SMOKING OR OPEN FLAMES

**⚠ WARNING**  
 AVOID SERIOUS INJURY OR DEATH  
 FROM FIRE OR EXPLOSION  
 RESULTING FROM LEAKING FUEL.  
 INSPECT SYSTEM FOR LEAKS AT  
 LEAST ONCE A YEAR.

**⚠ WARNING**  
 ROTATING PROPELLER MAY CAUSE  
 SERIOUS INJURY OR DEATH.  
 SHUT OFF ENGINE WHEN  
 NEAR PERSONS IN THE WATER.

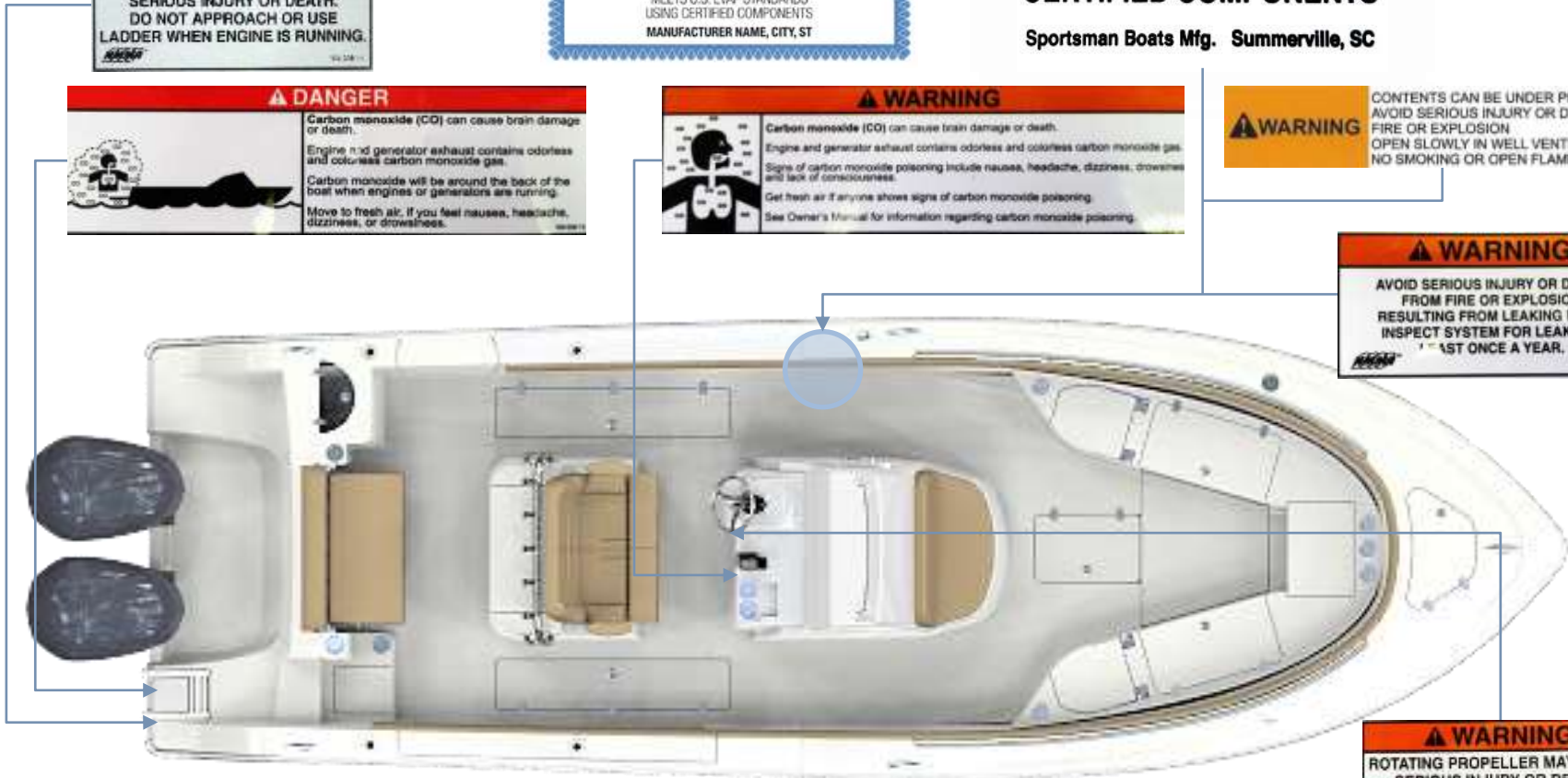

**SPORTSMAN**

# Electrical & Plumbing Systems

## Wire Harness

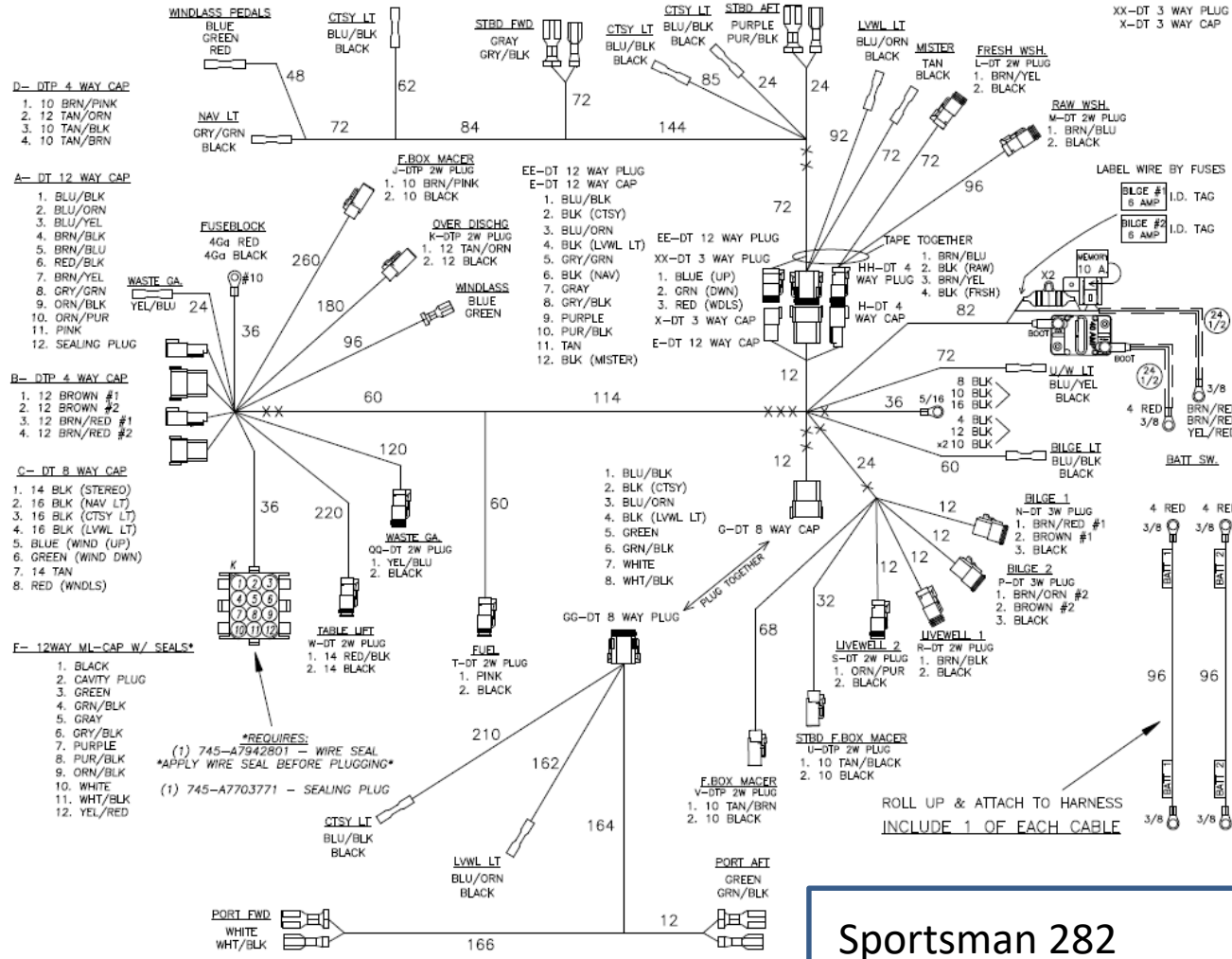

Fuse Panel

The fuse panel is located under the console. It is clearly labeled for easy identification. The bilge pump's 6 amp fuse is also located here. There is also a 30 amp breaker branching off the main battery switch. **If an electrical component of your boat stops working properly, this should be the first place to look.**

Sportsman 282



# *Electrical & Plumbing Systems*

## *Garmin 12" Package*

Sportsman offers the Garmin 1242xsv multi-function Display which integrates the following functions with ease:

- ClearVü
- SideVü
- Stereo
- Sonar
- Radar Capability
- Navigation
- Engine Instruments
- Coastal Charts





# Electrical & Plumbing Systems

## Garmin 12" Package

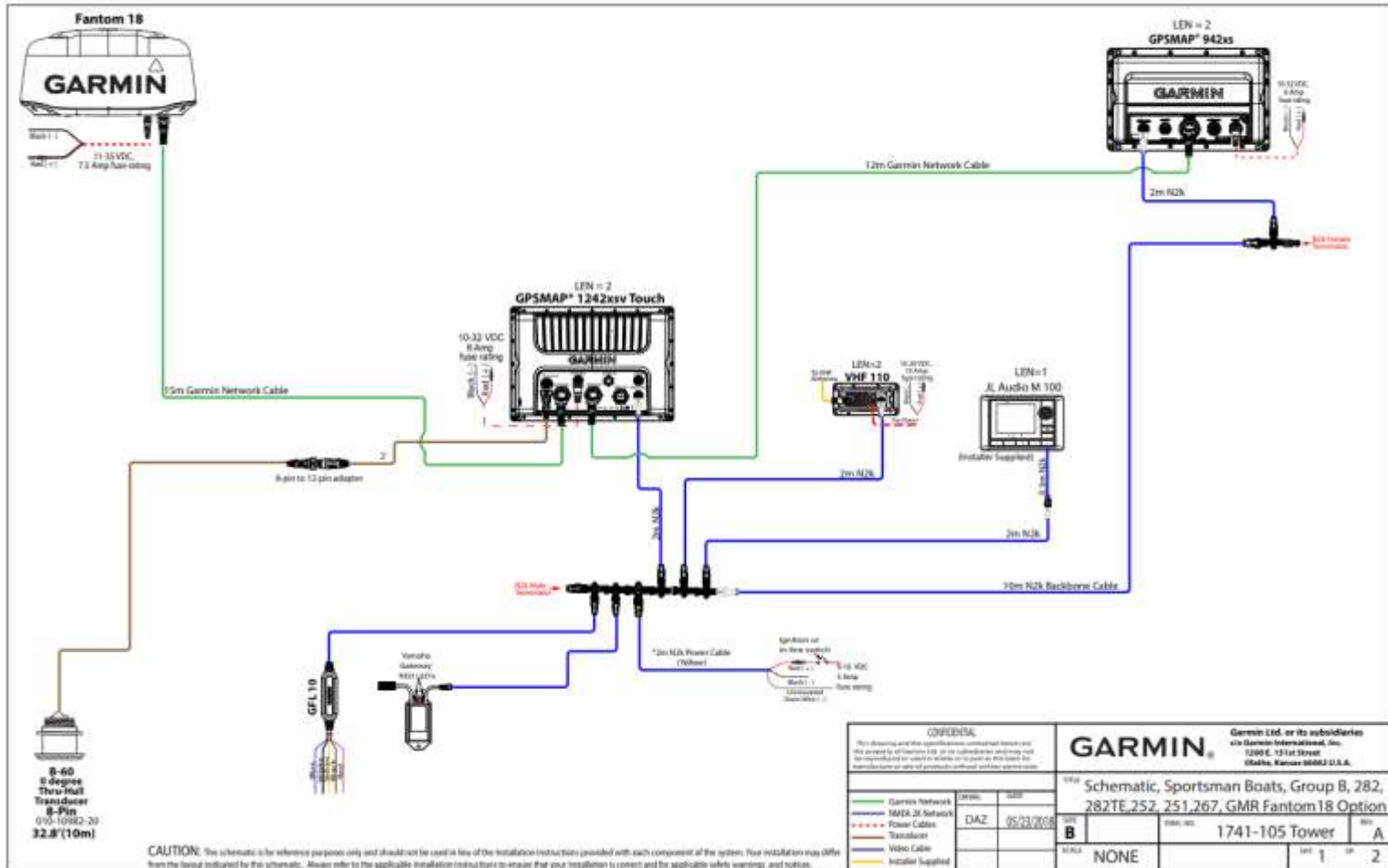

# SPORTSMAN

# Electrical & Plumbing Systems

## Optimus Electronic Power Steering



SeaStar's Optimus Electronic Power Steering (EPS) is at the forefront of boating technology. This system provides both the most comfortable and versatile maneuverability for your boat. When running at speed in open water, the steering system can be set to increase lock-to-lock turns to increase steering effort so the driver can effortlessly stay on course. At low speeds, Optimus may be adjusted for reducing the number of turns lock-to-lock. This will increase the sensitivity of the steering and enable tight, precise movements necessary for navigating through heavy traffic areas and tight spots. Optimus allows the boat to adapt to the environment as necessary to give the driver the most comfortable and pleasant experience possible.



**SPORTSMAN**

# Electrical & Plumbing Systems

## Optimus 360 Joystick Option



Sportsman offers the Optimus 360 as an option on the Open 282. This joystick significantly enhances the boat's maneuverability and ease of use at low speeds, such as pulling in or out of a slip. This allows you to move the boat sideways by pushing the stick left or right; you can also use this to rotate the boat about a point by twisting the joystick. It does this by moving each motor independently from one another at differing speeds and directions, as seen in the image below. To provide the smoothest possible motions and intuitive controls, the Optimus 360 is programmed to minimize the amount of shifting when practicing tight maneuvers. It also uses progressive throttling, which means a lighter push or twist will result in a slower, more precise motion than that of a strong push or twist. This system works seamlessly with the boat's components to give you total control when docking and navigating in tight areas.



# Electrical & Plumbing Systems

## Electric Actuated Bow Table



The Open 282 comes standard with an electric actuated table/sun deck at the bow. This table can be lowered into a notch in the deck to be used as a standing platform, but it can also be used as a sun deck or table by raising it with the push of a button. Raised halfway, the table aligns with the seats on each side so that you may put a cushion over it to extend the bow seating area. Raised all the way, as seen in the image here, it can be used as a table. The control for the table is located on the starboard side of the bow aft of the adjustable backrest below the cup holder, as shown in the figure.



Control Switch



# SPORTSMAN



# Electrical & Plumbing Systems

## Lights

The *NAV/ANC Switch* is a 3-position switch on the console that controls the running lights.

- **NAV** position will turn on the red and green navigation lights and the white all-round light for night driving.
- **ANC** turns on the all-round light only for night anchoring. Do not operate the boat in anchor position.
- Off is in the center position.

**Sidelights:** The Open 282 has integrated rub rail navigational lights installed at the bow (see figure to the right). A green light is located on the starboard (right) side and a red light on the port (left) side of the vessel. Each shows an unbroken light over an arc of the horizon of 112.5 degrees and is fixed to show from ahead to just behind the beams of the vessel on its respective side.

**All-round/Anchor Light:** This is a white light placed over the highest unobstructed point of the vessel, showing an unbroken light over an arc of the horizon of 225° and fixed to show from anywhere ahead, to just behind the beams of the vessel. See the figure to the right for location.

Recreational boats are required to display navigation lights between sunset and sunrise and other periods of reduced visibility (fog, rain, haze, etc.) Navigation lights are intended to keep other vessels informed of your presence and course. Your boat is equipped with the navigation lights required by the U.S. Coast Guard at the time of manufacture. It is up to you to make sure they are visible, operational and turned on.

### Bow Sidelights

The underwater lights can be turned on with the switch at the helm labeled "Accessory 1."

The anchor light on the Open 282 is located on the aft end of the T-Top. The location of the light is shown here without a visible T-Top.

### Anchor Light

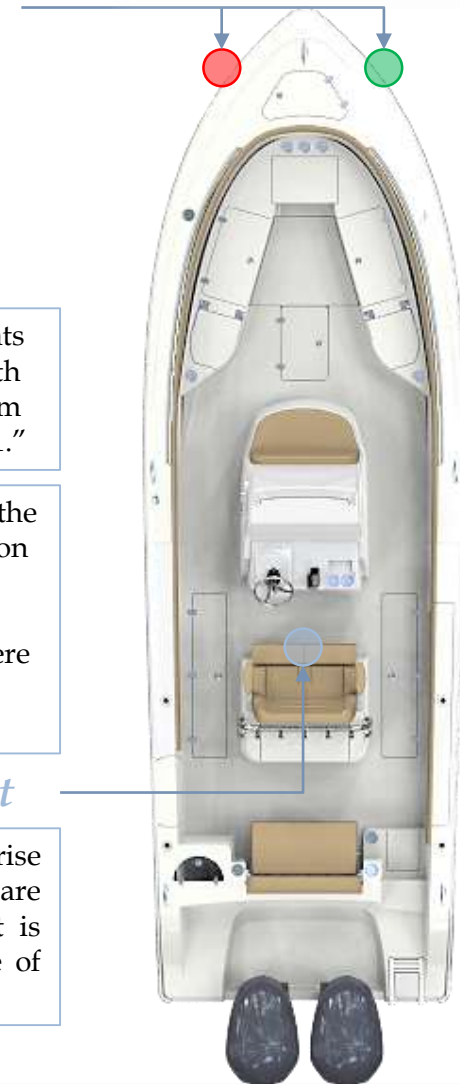



# Electrical & Plumbing Systems



## Stereo

Your boat is equipped with 6 standard JL Audio MX650 white sport grille speakers. **If you purchased the JL stereo upgrade option, this comes with 6 JL Audio M6 speakers, a 10" subwoofer. It also comes with a JL Audio M800/8v2 channel amplifier.**

Your boat has a Fiberglass T-Top, is standard with 4 JL Audio speakers. These four speakers will be located on the T-Top underside fore and aft.

Speakers

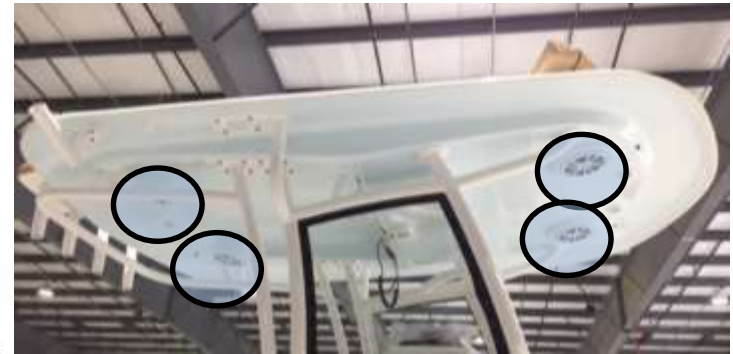
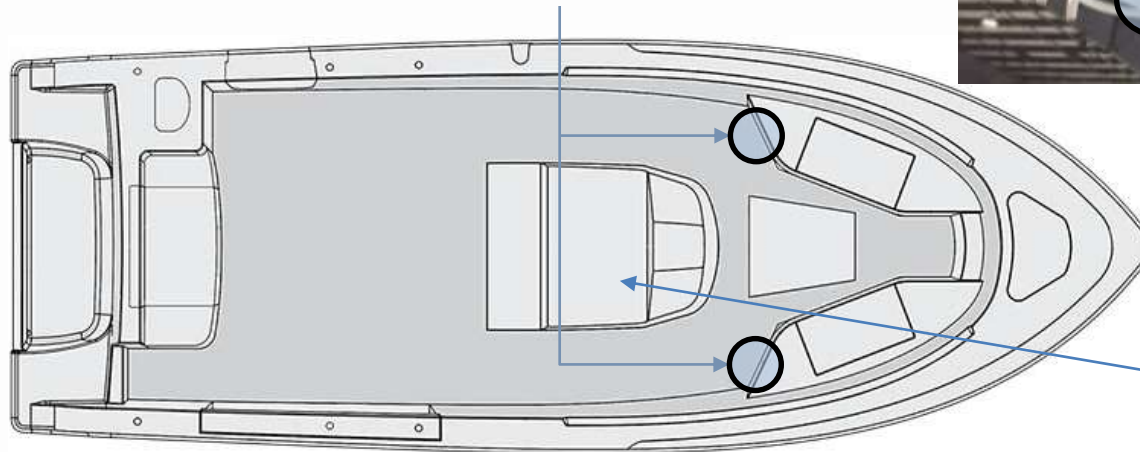

8 Channel Amplifier



# SPORTSMAN

# Electrical & Plumbing Systems

## Premium Stereo

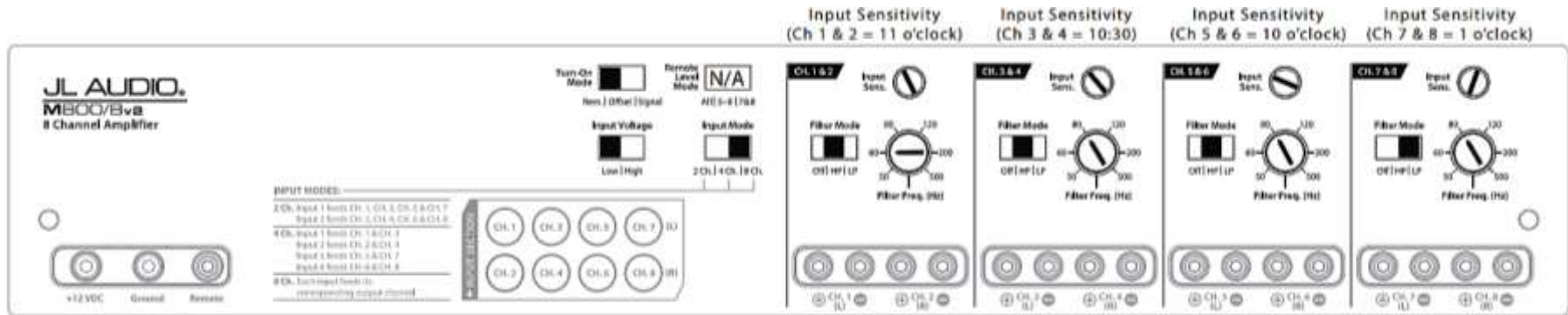

The Open 282 **Premium Stereo** is equipped with a M800/8v2 (8 channel Amplifier). This incredibly flexible amplifier packs a serious full-range punch and delivers a staggering 100 watts to each of its eight channels into 2 ohms (28.8V, 1% THD). The breakthrough that makes this much power possible in such a small chassis is our NexD™ ultra-high-speed switching design, which allows for full bandwidth Class D operation with extremely low distortion and outstanding efficiency.

# SPORTSMAN

# Electrical & Plumbing Systems

## Stereo Diagram

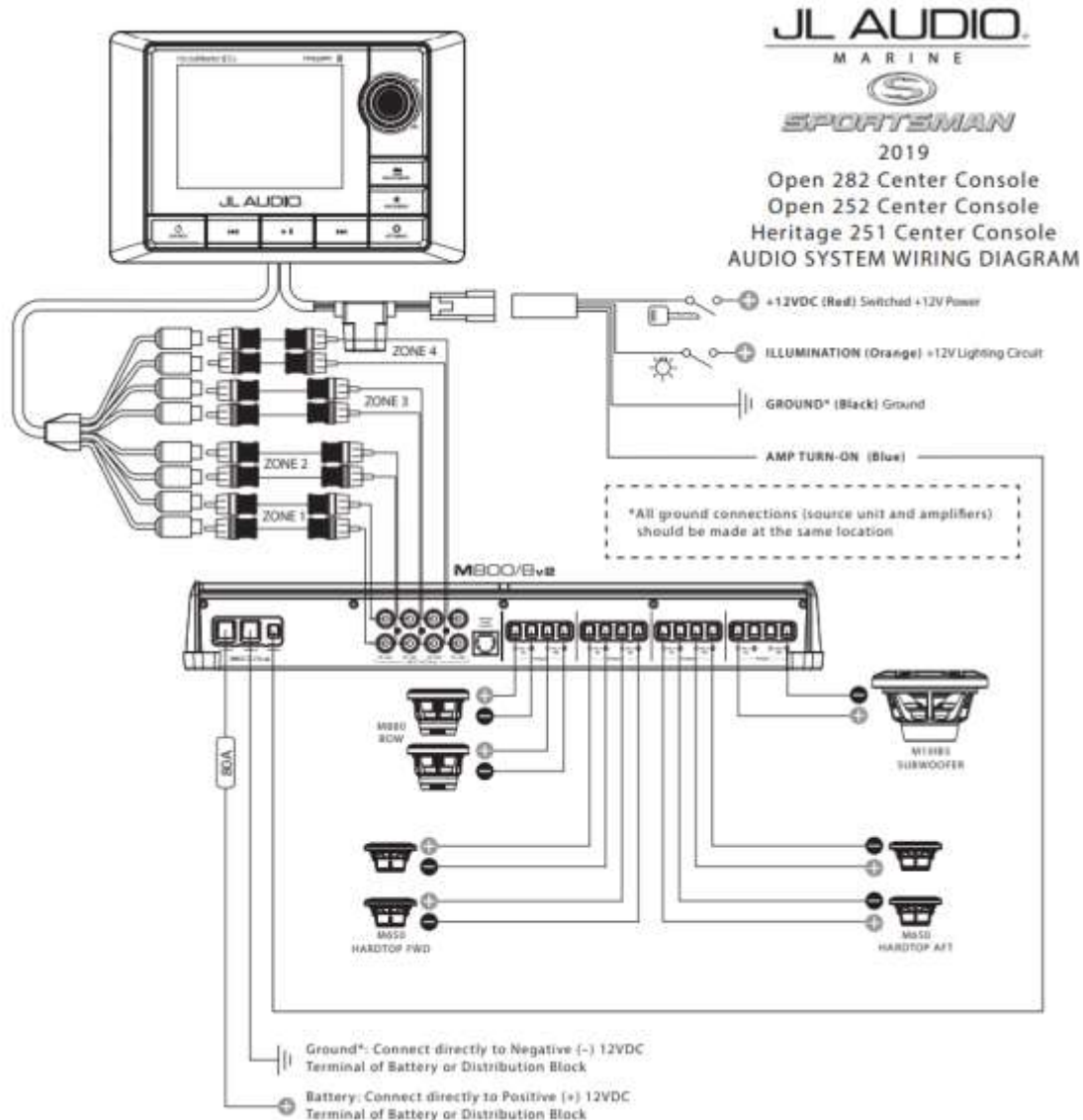

# Electrical & Plumbing Systems



## Trim Tabs

Your Open 282 has trim tabs installed as a standard feature. They are attached to the bottom edge of the transom, as shown in the image below. When the trim tabs control at the helm (pictured to the right) is pressed, the trim tabs automatically move into position. The force of passing water on these tabs results in upward pressure at the transom, which will lower the bow. This helps to improve the performance of the boat in a wide range of weight, weather, and water conditions. The LEDs on the control panel indicate the position of the tabs. If all are lit up, that tab is all the way down. The port and starboard tabs may be operated independently if necessary. To lower the starboard bow, lower the starboard tab. To lower the port bow, lower the port tab.



Control Panel



Trim Tab

**SPORTSMAN**

# Electrical & Plumbing Systems



## Trim Tabs

*If you keep your boat in a wet slip/marina environment.  
Here is a list of different anodes recommended for various water types to prolong the life and shine of your stainless steel tab.  
Never use a wire brush to clean your tab!*

### **Zinc Alloy Anodes = Salt water only**

Not recommended for use in fresh water  
Alloy is manufactured to meet or exceed US Military Specification (MIL-A-18001K)

### **Aluminum Alloy Anodes = Salt or Brackish water**

Not recommended for use in fresh water  
Proven to last longer than zinc due to increased capacity  
Alloy is manufactured to meet or exceed US Military Specification (MIL-A-24779(SH))

### **Magnesium Alloy Anodes = Fresh water only**

Not recommended for use in salt or brackish water



*Trim Tab*

# SPORTSMAN



# Electrical & Plumbing Systems

## Bilge Pumps

Two small bilge pumps are located on the hull bottom at the stern of your boat. Water is pumped out of thru-hull fittings located on the port and starboard sides of the boat near the transom. The pumps may be accessed by removing the aft seat and door, in the area shown to the right. You may turn your bilge pumps on manually by flipping on a bilge switch located on the switch panel at the helm. Additionally, the bilge pump utilizes a float as an automated switch to turn it on automatically if necessary when the boat is unattended. The bilge pumps are designed to remove excess water **only**, and they are **not** intended to stop or prevent rapid accumulation of on-board water due to rough weather, hull damage, or any other unsafe navigational conditions.



The rear seat easily detaches to allow easy access to the bilge area at the stern.



*Bilge Pumps*

*Drain Outlets*



**SPORTSMAN**

# Electrical & Plumbing Systems

## Fish Boxes

The Sportsman 282 Open features 2 fish boxes with macerators. The two fish boxes are located on each side of the leaning post; their macerators are inside the bilge area mounted to the side of the stringer. To operate the macerators, flip on the switch at the helm labeled "PORT FISHBOX & STBD FISHBOX." This will empty the fish box with a dual-cut blade design, which allows for thoroughly ground waste. The macerator will not process hard objects, such as bones and rags. The maximum flow rate is approximately 13 gallons per minute. The macerators discharge via a thru hull fitting on the port side mid-ship of the hull.

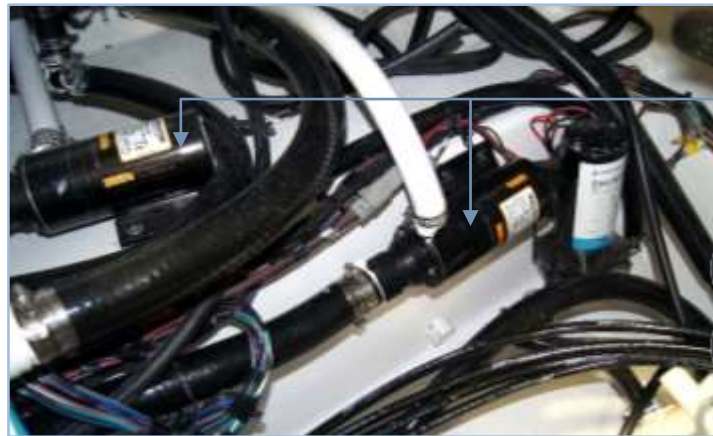

Macerators

Fish Box



**SPORTSMAN**

# Electrical & Plumbing Systems

## Livewells

The Sportsman Open 282 comes with a 30 gallon livewell at the port stern of the boat. For easy access to the pump and plumbing systems, remove the fold down seat and aft starboard door forward of the transom. The livewell pump is located on the side the bilge pumps in the hull of the boat, and the livewell fill hoses are connected to the top of the pump. To operate the livewell, open the pump valve in the bilge, turn on the livewell switch at the helm, and turn the fill valve in the livewell to "open." The switch labeled "Livewell 1" fills the livewell. The livewell is equipped with overflow drain so water cannot exceed a certain level and overflow. This overflow drains are connected to the main drain lines at 'T' joints, which empty out an outlet drain at the stern of the boat. Additionally, the livewell has LED lighting installed. To illuminate the livewell, turn on the switch at the helm.

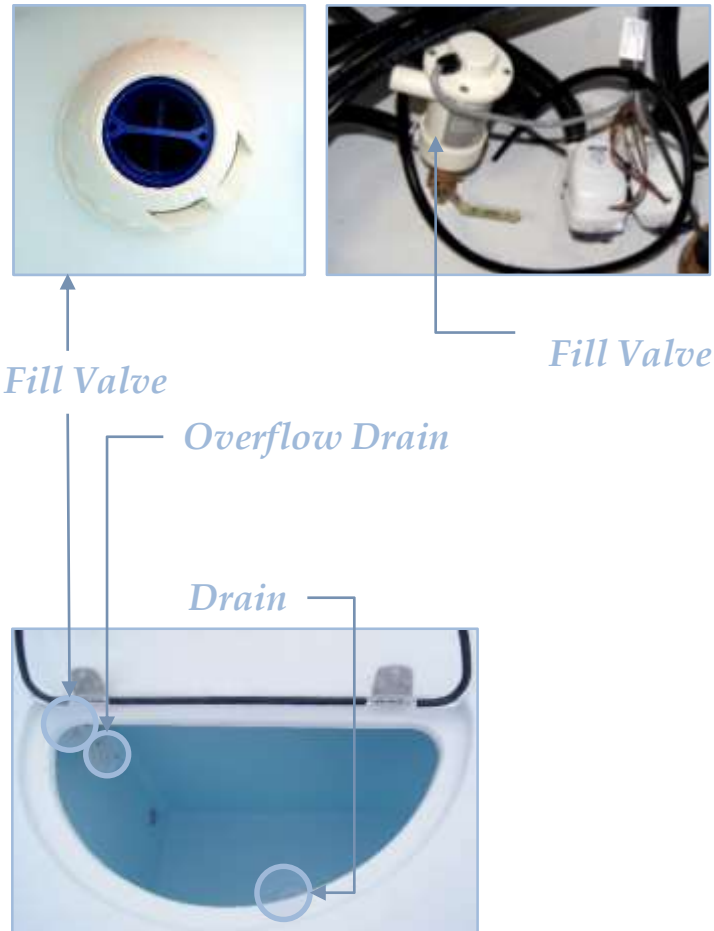

# Electrical & Plumbing Systems

## Raw Water Wash-down

Your Open 282 has the raw water wash-down installed as a standard feature. Rinsing your boat immediately after use with a powerful water jet helps to maintain the boat's condition and value. This system supplies water via a hose connected to bottom of the same pump that supplies water to your livewells with a shut off valve in the bilge area at the total access hatch. To operate the wash-down system, start by opening the valve mentioned above. Then turn on the switch labeled "RAW WATER" on the switch panel at the helm. The wash-down outlet is found on the starboard side of the boat under the gunwale. See the figures here for important feature locations for the raw water wash-down system.

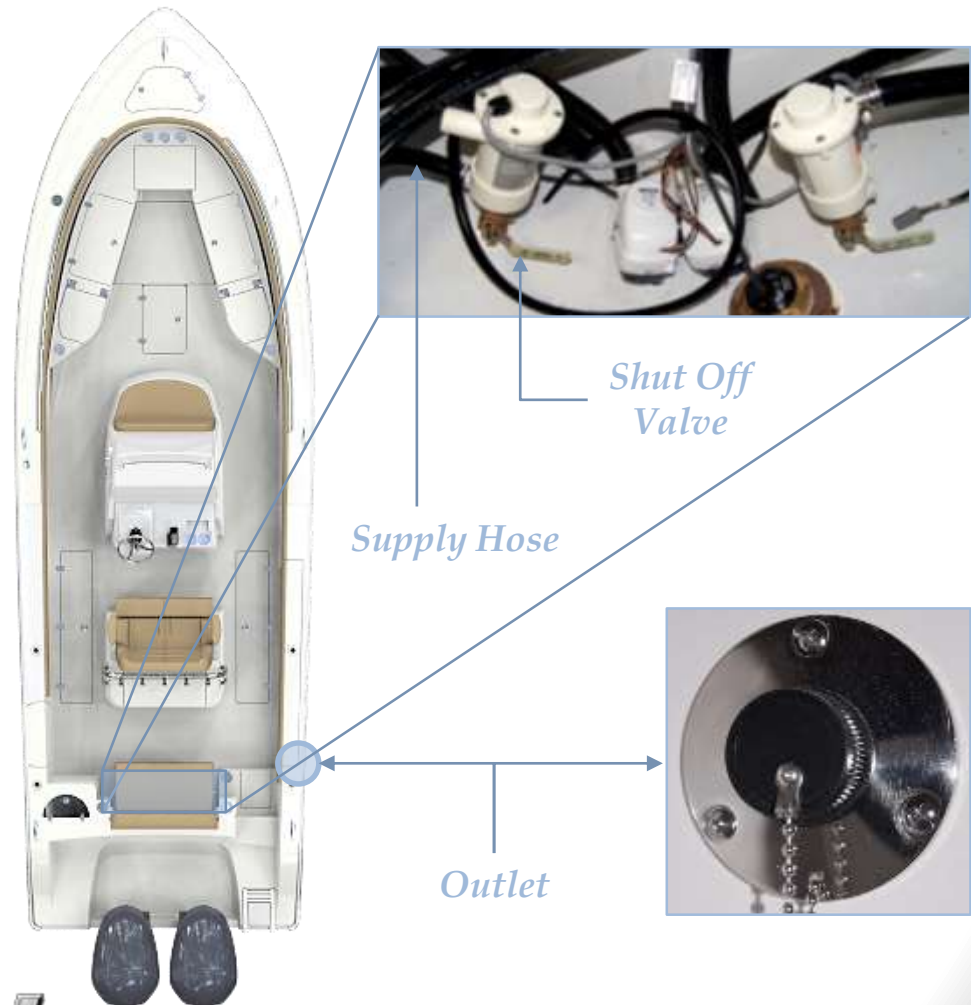

**SPORTSMAN**



# Electrical & Plumbing Systems

## Fresh Water Wash-down

Your Open 282 has the freshwater wash-down installed as a standard feature. The freshwater fill fitting is located near the motorwell. **Do not leave the tank full if your boat will be left unattended for an extended period of time;** pump the tank dry to avoid stagnant water in the tank if necessary. It is also important to periodically inspect and clean the filter, which is located on the pump. To operate this system, turn on the switch labeled "FRESH WATER" at the helm. This will pressurize the system for use. When the tank is empty or the boat is not in use, ensure that this switch is in the off position.



**SPORTSMAN**



# Electrical & Plumbing Systems



## *Porcelain Head with Overboard Discharge or Pump Out:*

*The Quiet-Flush Toilet provides a quiet operation, with user control of the flush. A single large push button switch provides a simple flush mode by activating both the rinse water supply and the macerator discharge pump simultaneously. An additional rocker switch offers independent control of the rinse water supply and discharge pump separately so the bowl water level can be raised and lowered by the user. The rinse water is supplied from the 13 gallon water tank in the starboard stern of the boat. Your waste tank can be emptied two ways.*

*Turning the Y valve handle to the pump out allows for removal from the waste deck fill located under the console cooler seat by a shoreside pump-out facility. Flip the handle to the OVBD Over Board Discharge and also turn on the OVBD Discharge switch at your helm to activates your macerator. Your waste will exit the boat at a through hull fitting on the starboard side mid-ship of the hull.*

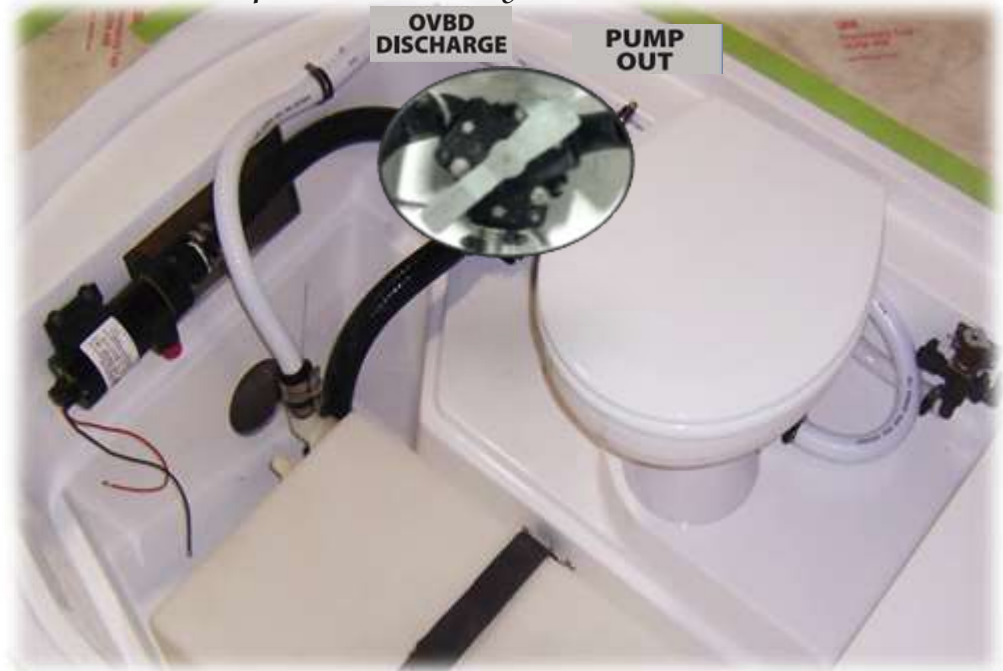

# SPORTSMAN

# Electrical & Plumbing Systems



## Overboard Discharge

*At all times, the valve must be positively secured in a way that presents a physical barrier to valve use and prevents all discharges. Adequate means include the use of padlock, non-releasable wire-tie, or removal of the valve handle. Federal law prohibits the discharge of untreated sewage from vessels within navigable waters of the United States, which include territorial seas within three miles of shore and most bays and estuaries. Check with your local authorities or Coast Guard for any rules which apply to the area where you do your boating.*



**SPORTSMAN**

# Windless System

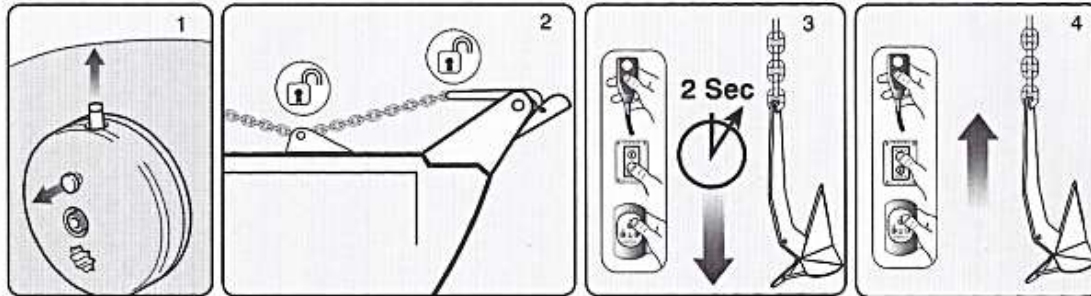

## To release anchor:

1. Check unit is not in manual mode and plunger is disengaged/up position.
2. Release any anchor locks.
3. Engage the circuit breaker/isolator.

When releasing the anchor, press DOWN button for 2 seconds until the anchor is under freefall. If the clutch was left in a locked position the anchor will move almost immediately, if unlocked it could take several seconds to fully re-engage the internal clutch.

NOTE: Pressing the DOWN button for over 5 seconds will result in a longer clutch re-engagement time during the next UP command).

If using a rope/chain rode, motor astern to create the desired scope. Once scope has been created press the UP button continuously until freefall stops. It normally takes several seconds to fully re-engage the internal clutch mechanism, locking the windlass.

NOTE: Failure to lock the windlass clutch could result in rope/chain creeping out.

## To retrieve anchor:

4. Press the UP button continuously to retrieve the anchor.



# SPORTSMAN



# Fuel System

## Fuel Tank

The Sportsman Open 282 comes with a fuel tank installed (195 approximate usable gallon capacity). The gasoline fuel system consists of a fuel tank (located underneath the helm seat as shown in the figure), anti-siphon valve, engine fuel supply line, and fill cap. Your boat contains a new EPA certified fuel system. The system prevents spit-back when filling the tanks and lowers the out gassing emissions through a vent in the new designed fuel fill cap.

*Note: This photo was taken during the assembly process. At this stage, some of the hoses had not yet been connected. In your boat all lines and hoses will be connected as necessary.*

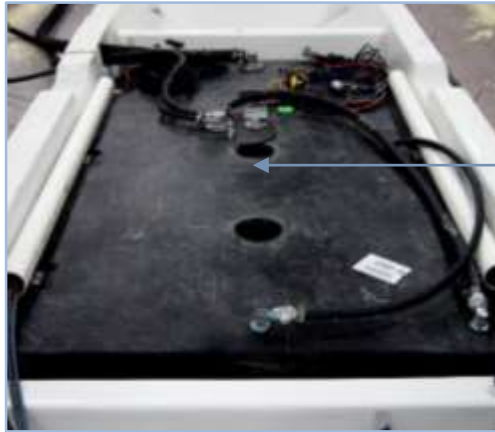

# SPORTSMAN

# Fuel System

## Diurnal Fuel System



**BluSkies**

## EPA DIURNAL FUEL SYSTEMS

**NOTE: Pressure may be present when opening your deck fill, regardless of system type.**



**Only open the fuel cap for refueling**

Note: The first time fuel is introduced to a fuel tank, be aware of the interaction of cold raw fuel vapors replacing air, on occasion a vapor pressure can occur producing spit-back anomalies!

### What is a diurnal fuel system?

Your new vessel is equipped with an Environmental Protection Agency (EPA) compliant diurnal fuel system, designed to reduce fuel emissions to atmosphere using criteria mandated by the EPA. Your vessel's fuel tank is required and designed to have a positive pressure (>1PSI) as the sun heats the boat and the fuel in the tank expands or it may be equipped with a carbon canister to catch and contain fuel vapors

Your boat's fuel tank also has valves installed inside that are designed to:

1. Produce a clean refueling shut off event
2. Create a 5% vapor space
3. Reduce the propensity of a refueling spit-back event.
4. Allow for appropriate venting when the vessel is stored or trailered. Your fuel cap also contains valves designed to retain fuel vapor (up to 1PSIG) and to allow make up air during engine operation

**SPORTSMAN**





# Fuel System

## Diurnal Fuel System (cont'd)

### Vapor Space (Ullage) And Refueling Management

Another fuel system necessity to remain EPA compliant it is to keep elevated temperature gasoline from expanding into fuel system areas that are not low permeation rated or otherwise sensitive to raw fuel. A vapor (or ullage) space must be produced at the completion of the filling or refueling operation to ensure systems remain EPA compliant during the diurnal temperature cycle. To effectively manage this system function, BluSkies has created a series of valves that can mount to any marine fuel tank to achieve the appropriate fill level while maintaining ullage space of ~5%. Additionally these valves eliminate the propensity for refueling "spit-back" or tank "well-back", which is another requirement of the EPA regulation. BluSkies primary ullage valves replace the existing fill and vent locations, while additional grade or tip level valves can be added to any tank to meet American Boat And Yacht Council standards (H-24) which allows vapor venting for boats slanting or sloping when stored, moored, parked or trailered.

The final decision on which system type and ullage valve type and placement that is best for your application should be based on application specific factors such as type and configuration of fuel tank, how much room there on board is for added components, how are the boats likely to be used and stored etc. and of course cost.

Choose individual components to create a compliant system from the following pages or you can turn to our specialists for sound guidance and direction as you go through the process to choosing the appropriate system for your particular vessel application.

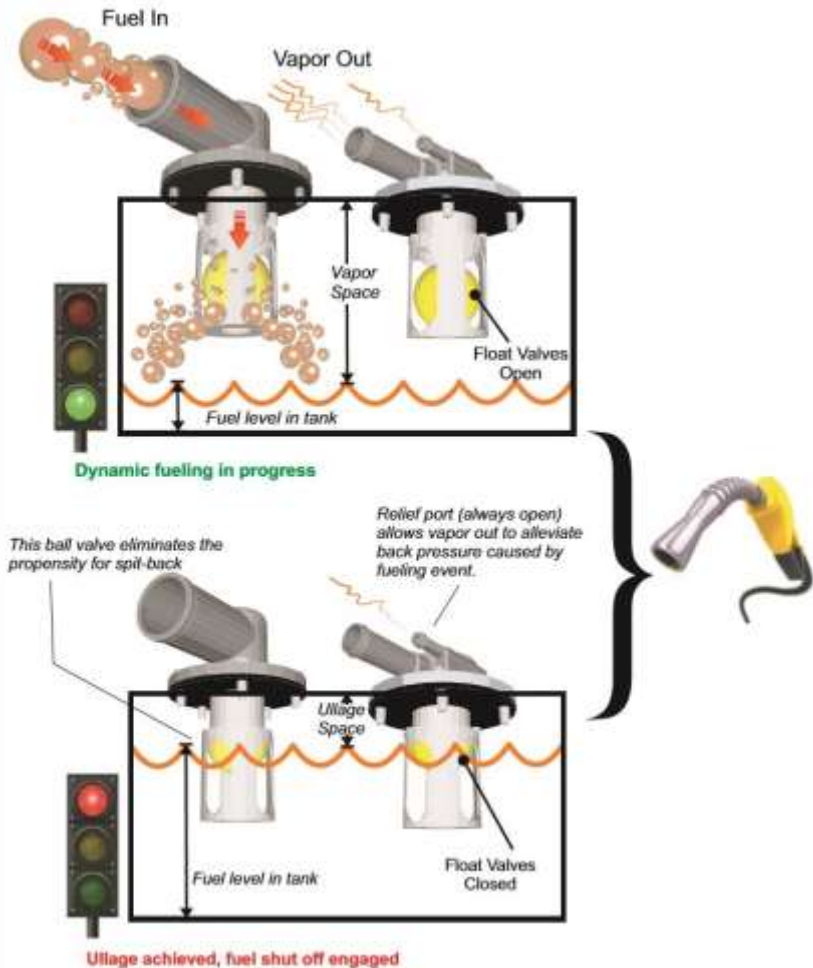

# SPORTSMAN

# Fuel System

## Tank Vapor Space & Fluid Management

### Ullage (Vapor Space) Level Attainment Spit-back/Well-back Control

This vent valve shuts off the refueling vapors and creates back pressure to lift the fill valve ball into place.

This fill valve ball is set lower than the vent valve ball but does not close until the refueling vapors are shut off by the vent valve.

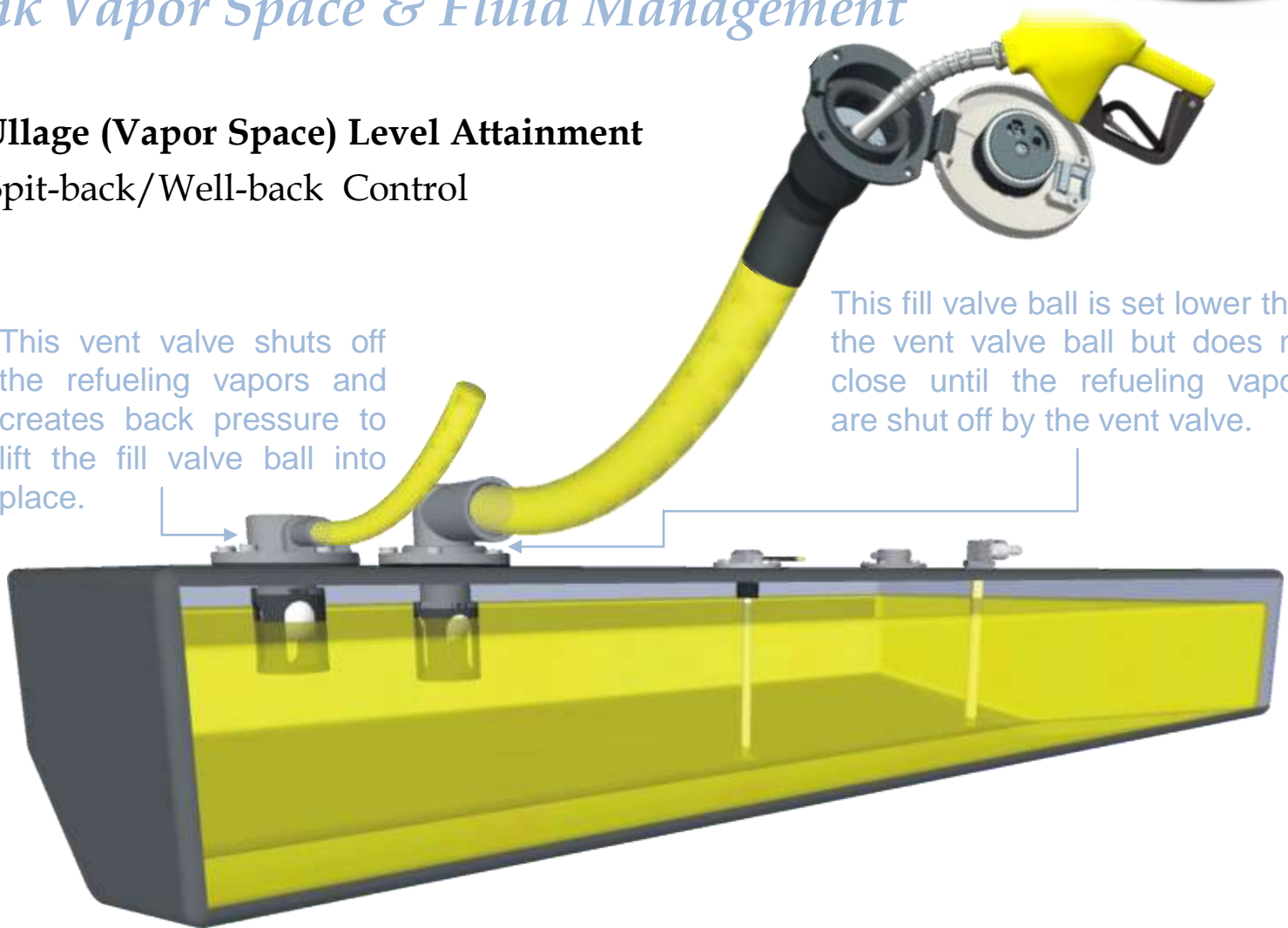

# Fuel System

## Diurnal Fuel System: Refueling



Your fuel tank capacity will vary from the label or published capacity no less than 5% by law and up to 10% dependent upon the variation from static float due to equipment, occupants and gear etc. (Static Float = attitude in which your boat floats in calm water)

**Fill your vessel fuel tank as normal, stop refueling after two (shut off) clicks of the fuel nozzle.**

Topping off will over ride your fuel system design intent and could cause damage to your vessel due to overflow and will void any and all warranty claims related to fuel spillage.

BluSkies is expressly not responsible for any damage to your vessel subsequent to topping off.

### WARNING

CONTENTS CAN BE UNDER PRESSURE  
AVOID SERIOUS INJURY OR DEATH FROM  
FIRE OR EXPLOSION  
OPEN SLOWLY IN WELL VENTILATED AREA  
NO SMOKING OR OPEN FLAMES

It has been a common practice for many years to top off boats prior to storage or in preparation for a day on the water, however diurnal fuel systems are designed specifically to leave a space in your fuel tank to allow the fuel to expand during the heat of the day. GASOLINE EXPANDS 5%.

### REFUELING

GASOLINE CONTENTS UNDER PRESSURE. FUEL SPRAY MAY OCCUR.

1. OPEN CAP SLOWLY
2. INSERT FUEL NOZZLE
3. BEGIN & CONTINUE FUELING UNTIL FUEL NOZZLE KICKS OFF
4. WAIT 10 SECONDS & CONTINUE FUELING UNTIL NOZZLE KICKS OFF A SECOND TIME
5. RETURN NOZZLE TO PUMP
6. DO NOT TOP OFF

# SPORTSMAN



# Boating Navigation Rules

There are three main situations that you may encounter with other vessels which could lead to a collision unless the Steering Rules are followed:

- Meeting**: you are approaching another vessel head-on
- Crossing**: you are travelling across the path of another vessel
- Overtaking**: you are passing or being passed by another vessel

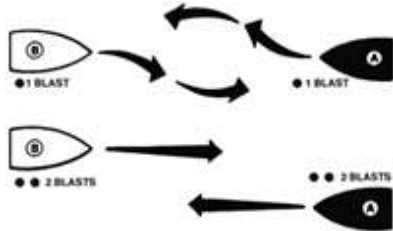

**When Meeting Port-to-port:** Continue on course. The same holds true for meeting starboard-to-starboard.

**When Meeting Head On:** As in a car, both stay to your right and as far apart as practical. Each boat should turn to starboard and pass port-to-port.

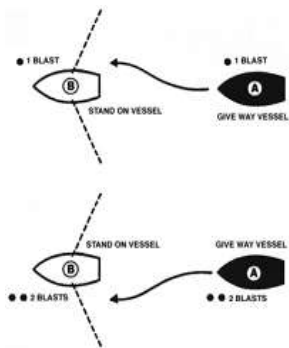

**When Crossing:** Every boat has a "Danger Zone" from straight in front (the bow) to past the middle of its right side. Like when meeting another car at a street intersection, the one on the right has the right of way. You must yield to boats in your Danger Zone. If you are the skipper of the Vessel A in the center of the diagram, you must keep out of the way of any boat that approaches you from any direction within the indicated Danger Zone, as you are the burdened craft. Likewise, boats approaching you from all other directions, except the meeting vessel, must keep clear of you.

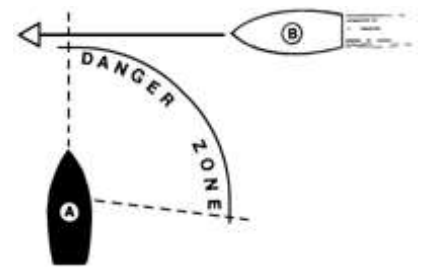

**When Overtaking Another Boat:** The boat being overtaken is the privileged vessel. Only after signaling and receiving an acknowledgment can the overtaking boat pass. (Use one blast to pass on the right, and two blasts to pass on the left.)

**When Being Overtaken:** Be ready for trouble when a power boat passes you in a narrow waterway. As the lead boat, which always has the right of way, stay on your side of the channel and maintain a steady speed so that the overtaking vessel can pass you safely. Use your radio to discuss this with the passing boat.



# Warranty and Services



## *Product Changes*

Sportsman is committed the development of our product line. As a result, equipment described in this manual may have changed or no longer may be available. All information, illustrations and specifications contained in this manual reflect the latest product information available at the time of publication. Sportsman reserves the right to make changes to its boats at any time, without notice. These changes include, but are not limited to: color options, materials, standard and optional equipment, specifications and model availability. If you have any questions about the equipment on your boat, please feel free to contact Sportsman.

## *Insurance*

In most states, the boat owner is legally responsible for damages or injuries they or anyone else operating the boat causes. Some states have laws that require having at least minimum coverage. Before using your boat for the first time, you should contact your dealer, current insurance company, or state boating authority for information regarding insurance requirements in your area. Although it may not be required in your area, responsible boat owners carry liability and property damage for their boat. You should also protect the boat against physical damage and theft.

## *Service*

All warranty work must be performed by an authorized Sportsman Dealer. If a problem is discovered upon taking delivery of, or develops during routine use of the boat that is related to faulty workmanship and/or materials, as stated in the warranty, you need to contact your Sportsman dealer to arrange for your boat to be repaired. **The boat owner is responsible for delivering the boat to the dealer for warranty service.** If you are not near your dealer or any other authorized Sportsman dealer, please contact Sportsman. Likewise, if the dealer fails to repair the problem, please notify Sportsman within 14 days of the work being completed. **Sportsman will not reimburse owners for unauthorized warranty work.**

# **SPORTSMAN**

---





# Warranty and Services

## SPORTSMAN BOATS LIMITED WARRANTY

**Ten-Year Hull Limited Warranty:** This limited Warranty applies to any Structural Hull Defect (as that term is defined below) if such is due to a failure in material or workmanship and the was reported to Sportsman according to the terms of this Limited Warranty within ten (10) years from the date of the sale to the original purchaser of the Sportsman authorized dealer. Sportsman, in its sole discretion, will either repair or replace the Hull. For purposes of this Limited Warranty, the term “Hull” shall mean the single fiberglass molded shell and integral structural components of a Sportsman Boat, and the term “Structural Hull Defect” shall mean a substantial defect in the Sports Boat’s Hull that causes the boat to be unfit or unsafe for general use as a pleasure craft under normal operating conditions.

**One Year Nonstructural Limited Warranty:** This Limited Warranty applies to any Nonstructural Defect (as that term is defined below) if such is due to a failure in material or workmanship and the same was reported to Sportsman according to the terms of this Limited Warranty within one (1) year from the date of the sale to the original purchaser of the Sportsman Boat by a Sportsman authorized dealer. Sportsman, in its sole discretion, will either repair or replace the defective component. For purpose of this Limited Warranty, the term “Nonstructural Defect” shall mean a substantial defect in a Sportsman Boat’s components manufactured or installed by Sportsman (other than the Hull) that is not excluded in the exclusions below.

**Registration and Transfer of Limited Warranty:** Each original purchaser of a Sportsman Boat shall complete and return the boat registration card provided by Sportsman within thirty (30) days of such owner’s purchase of the boat in order to facilitate the processing of warranty claims and for manufacture notification. Except where a Sportsman Boats has been salvaged and resold after a declaration of a total loss or a total loss or a constructive total loss, this Limited Warranty is transferrable to a subsequent owner of the Sportsman Boat. PROVIDED SUCH SUBSEQUENT OWNER FILL OUT AND SEND TO SPORTSMAN A SPORTSMAN WARRANTY TRANSFER FORM (AVAILABLE FROM SPORTSMAN ON REQUEST). A COPY OF THE BILL OF SALE, WHITHIN THIRTY (30) DAYS OF SUCH TRANSFER OR PURCHASE.



# Warranty and Services

## SPORTSMAN BOATS LIMITED WARRANTY (cont'd)

### EXCLUSIONS:

This limited Warranty does not apply to any boat that has been salvaged or declared a total loss or constructive total loss for any reason not specifically covered in this Limited Warranty. In addition, this Limited Warranty does not apply to the following "Exclusions:"

- 1) A Hull, component, or other product that has been repaired without authorization of Sportsman or that has been altered in any way that affects its use and operation;
- 2) Expenses related to inspection or warranty service for hauling out, transportation to and from any dealer or Sportsman factory, towing or storage charges, inconvenience or loss of time or income;
- 3) Engines, outdrives, controls, propellers, engine brackets, stereos, depth finder, GPS units, trolling motors, batteries, outriggers bases' and other equipment or accessories that are not manufactured by Sportsman, whether the same is or is not warranted by such other manufacturer;
- 4) Blistering, discoloring, cracking, or crazing of the Gelcoat finish or other surface finishes
- 5) Any Sportsman Boat initially sold at retail by a party other than an authorized Sportsman dealer;
- 6) Damage to, breakage of, or leakage around any windshields, hatches, or apertures;
- 7) Any canvas, zippers, vinyl, upholstery, plastic, or fabric components;
- 8) Discoloration, oxidation, bleeding, or corrosion of any stainless steel or other metal products
- 9) Any Hull, component, or product that has been subject to unreasonable use, tampering, abuse, mishandling, improper maintenance, negligence, improper trailing, alterations, or accidents;
- 10) Any boat, or component or part thereof, that has been used for Commercial Purpose, racing purposes, or has otherwise been operated contrary to any printed instruction provided by Sportsman or contrary to any applicable law (for purposes of this Limited Warranty, the term "**Commercial Purposes**" shall mean the usage of any boat more than fifty percent (50%) for revenue-producing or other business purposes);
- 11) A boat, or component or part thereof, that has been overpowered according to the maximum recommended engine horsepower specified on the capacity plate attached to the boat;
- 12) Machinery, equipment and accessories not installed by Sportsman;
- 13) Condensation of gauges;
- 14) The failure of any part, area, or component of the boat to be dry, whether or not the same was represented as "dry";
- 15) Any representation relating to the speed or weight of any part or component of the boat;
- 16) Normal wear and tear maintenance items, including, but not limited to, filters bulbs, batteries, bungees, anchor rope, trailer finishes, tires, brakes, bearing, and lights;
- 17) Any defect or repair requiring redesign of the boat, except pursuant to the recall provisions of the United States Federal Boat Safety Act of 1971 or the recall laws of the recall laws of any other foreign jurisdiction;
- 18) Dealer preparation, cleaning, and final adjustments and alignments in preparing the boat for delivery or commissioning; or
- 19) Any act of God or force majeure.

# SPORTSMAN

Thank you for your purchase of your Sportsman Boat.

Sportsman Boats Manufacturing, Inc.  
113 Isaac Way · Summerville, South Carolina 29483  
Telephone (843) 376-2628 · Fax (843) 376-2636

Email  
*sales@sportsmanboatsmfg.com*

Website  
*www.sportsmanboatsmfg.com*

P.O. Box 2100  
Summerville, SC 29484



***SPORTSMAN***