



SPORTSMAN

*Owner's Manual and
Quick-Reference Guide
2019*

Table of Contents



<i>Topic</i>	<i>Page</i>
Introduction	3
Important Information	4
Specifications	5
Overall Dimensions & Terminology	6
Features & Performance	7
Certifications & Registrations	11
Boating Safety	12
Electrical & Plumbing Systems	18
Fuel System	32
Boating Navigation Rules	37
Warranty & Services	38
Contact Information	41

Introduction



WELCOME TO THE SPORTSMAN TEAM!

Here at Sportsman Boats, we take great pride in producing the finest, most well designed saltwater fishing and pleasure boats on the market today. Our designs incorporate the most modern technology while applying good old "Common Sense" technology as well. From our advanced composite construction, ergonomic console designs, patented "Total Access" hatch, and superior ride and handling characteristics, we think you will agree that Sportsman is setting a new standard. Sportsman Boats builds the fastest growing line of family-friendly center console boats in-class, built with the latest designs, procedures and materials to give you and your family unparalleled performance with a dry, safe and comfortable ride

We do not take lightly the confidence you have placed in us with your decision to purchase your Sportsman boat. We will always strive to provide for you and your family the superior customer service you deserve. We hope that you enjoy your time out on the water as much as we enjoy building your Sportsman boat!

Safe Boating and Tight Lines,
Tommy Hancock

SPORTSMAN



Important Information

BOAT INFORMATION / SPECIFICATIONS	
MODEL:	HULL SERIAL #:
PURCHASE DATE:	DELIVERED:
IGNITION KEY #:	REGISTRATION #:
DRAFT:	WEIGHT:
VERTICAL CLEARANCE:	
ENGINE / PROPELLER INFORMATION	
ENGINE MAKE:	MODEL:
ENGINE SERIAL #:	
PROPELLER MAKE:	# OF BLADES:
DIAMETER / PITCH:	MODEL:
PART #:	
OPTIONAL EQUIPMENT / OPTION PACKAGES	
TRAILER INFORMATION	
MAKE:	MODEL:
SERIAL #:	GVRM:
ADDITIONAL INFORMATION:	
DEALER	SPORTSMAN
NAME:	PHONE:
PHONE:	REPRESENTATIVE:
SALES PERSON:	ADDRESS:
SERVICE MANGER:	
ADDRESS:	

We recommend filling out the information in this table and keeping one copy of this page in your personal records and one copy with your owner's manual. This information will be important should you need to contact your dealer or Sportsman Boats Manufacturing for technical assistance and/or service.

Specifications



Length Overall	24'4"
Beam	8'5"
Draft	14"
Deadrise at Transom	15°
Approximate Usable Fuel Capacity	71 gal.
Approximate Dry Weight	2650 lbs.
People Capacity	10 persons
Maximum Engine Horse Power	300 HP (4 Stroke)

SPORTSMAN

Overall Dimensions & Terminology

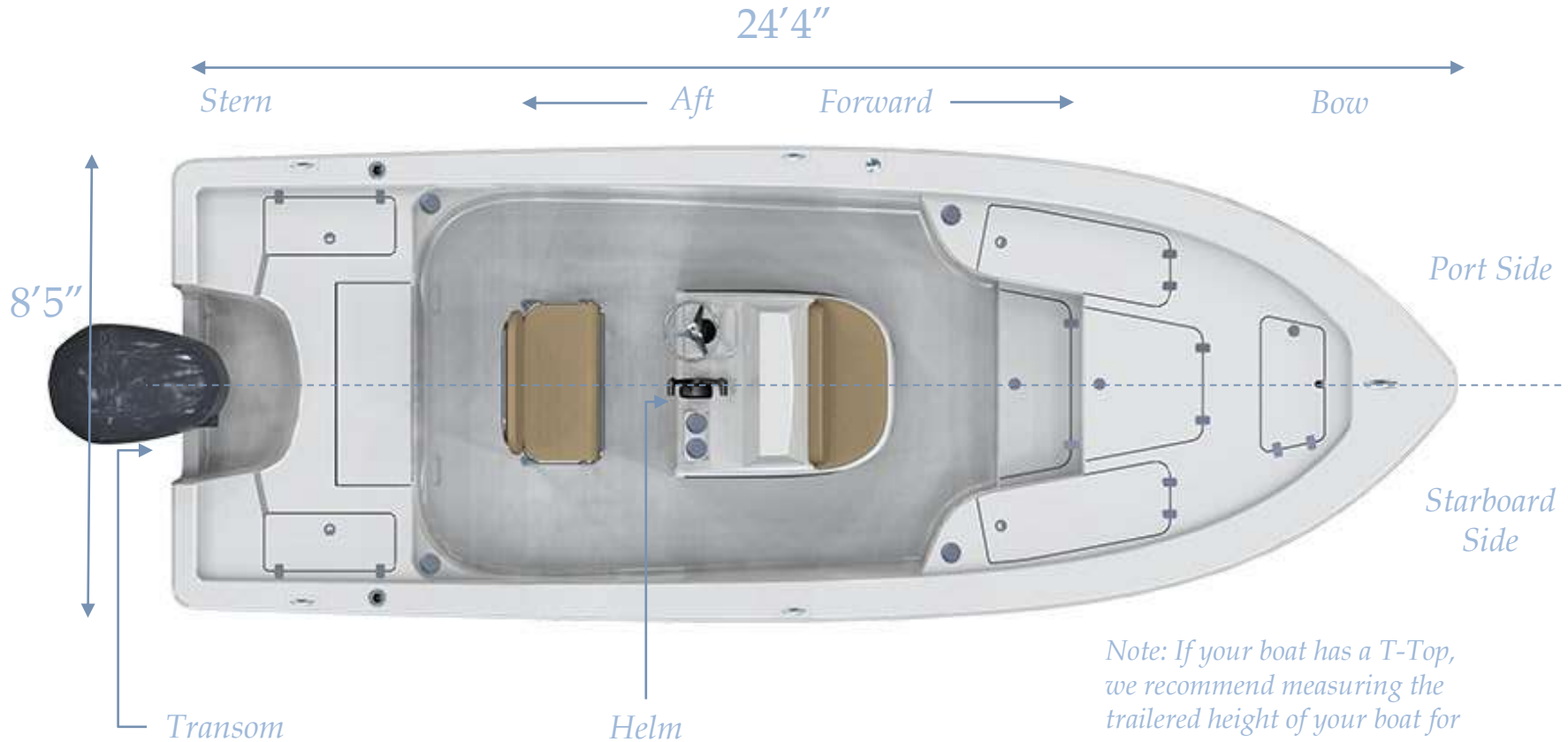

Note: If your boat has a T-Top, we recommend measuring the trailered height of your boat for towing safety purposes. This height may depend on the specific trailer being used.

SPORTSMAN

Features & Performance

Standard Package



- SportTech™ Advanced Fabrication Process
- SportLink™ Electronics Integration System
- Garmin GPSMAP® 1242xsv Touch MFD 12"
- Airmar B60 Thru-Hull Transducer
- Garmin VHF 110 Radio w/ Antenna
- JL Audio MediaMaster® MM50 Premium Marine Stereo
- (8) JL Audio MX650 White Sport Grille Speakers
- (1) 25 Gallon Rear Livewell
- (1) 25 Gallon Rear Recirculating Livewell w/Pro-Air
- 10-Year Hull Warranty
- 12 Gallon Livewell Front Seat of Console
- 13 Gallon Freshwater Tank w/ Washdown
- 4 Flush Mount Gunwale Rod Holders
- 71 Gallon Fuel Tank w/ Fuel Level Sensor
- Advanced Fiberglass Stringer System (No Wood)
- Anchor Storage
- Compass
- Console Footrest w/ Glove Box & Storage Bin
- Console Interior Liner
- Console Windscreen
- Dash Panel Cover
- Dual Battery Configuration w/ Switch & Trays
- Extra Large Forward Storage Box
- Fiberglass Hard-Top w/ LED Lighting & Misters
- Grip Tex Yacht Style Non-Skid
- Helm Pad
- High Speed Livewell Pick Up
- Horn
- Hydraulic Tilt Steering
- Interior LED Lighting Package
- JL Audio Combo USB & 3.5 mm Audio Jack
- Large Bow Casting Deck w/ Lockable Storage for 10 Rods
- Large Bow Fish Box
- Large Rear Casting Deck
- Light Hull Color
- Lockable Console Storage
- Matching Hard-Top Underside Color
- NMMA Certified
- Premium Dual Chair LP w/ Flip Up Bolsters
- Premium Marine Vinyl with Distressed Look
- Pull-Up Cleats
- Raw Water Washdown
- Rear Fold Up Bench Seat w/ Storage
- Rear Total Access Hatch
- Recessed Bow Hand Rails
- Rub Rail Navigation Lights
- Self Bailing Cockpit
- Spray Shield
- Stainless Steel Cup Holders - 7
- Stainless Steel Propeller
- Stainless Steel Rub Rail
- Stainless Steel Steering Wheel w/ Knob
- Stainless Steel Switches
- Swim Platform w/ 3 Step Ladder
- Trim Tabs w/ LED Indicator
- Trolling Motor Plug/Harness
- Under Gunwale Rod Racks
- Underlid Gasket
- Underwater Lights

Color Selection

Powder Coat Selection

- Black
- White

- Driftwood
- Ice Blue
- Island Blue
- Jet Black
- Sea Mist Green
- Silver Cloud
- Steel Blue
- White

SPORTSMAN



Features & Performance

Options

- Second Garmin GPSMAP® 1242xsv Touch 12"
- Garmin GMR™ Fantom 18 Radome
- Garmin Reactor™ 40 Autopilot (req. EPS)
- Garmin GXM™ 53 SiriusXM® Weather Antenna
- JL Audio M6/MM100/Amps Package
- Airmar B175M CHIRP Thru-Hull Transducer Upgrade
- Bow Casting Chair
- Bow Cushion Set / Sundeck
- Console Cover
- Custom Color Engine
- Dark Hull Color(Black/St Blue)

- Edson 13" SS Comfort Grip Steering Wheel w/ PowerKnob
- Fiberglass LP w/ Built-In 30 gal. Livewell
- Fiberglass LP w/ Tackle Center
- Gull Wings
- Gunwale Rod Holders / Each
- ICON Cooler w/ Slide Out Track
- Mooring Cover
- On-Board Battery Charging System
- Optimus Electronic Power Steering w/ Tilt
- Powder Coating
- Powder Coating for Ski Tow Bar

- Removable Reclining Bow Backrest w/ Seat Cushions
- SeaStar Jack Plate (incl. Splash Well Filler Board)
- SeaStar ProTap Controller (req. Jack Plate)
- Ski Tow Bar
- Sun Shade w/ Poles - Front
- Sun Shade w/ Poles - Rear
- Taco Outriggers - GS280
- Transhield Shipping Cover
- Under Leaning Post Tackle Storage
- Underwater Lights

Stereo Upgrade

- JL Speakers
- JL Amplifier
- 8" Amplified Subwooferv

Features & Performance

Major Features

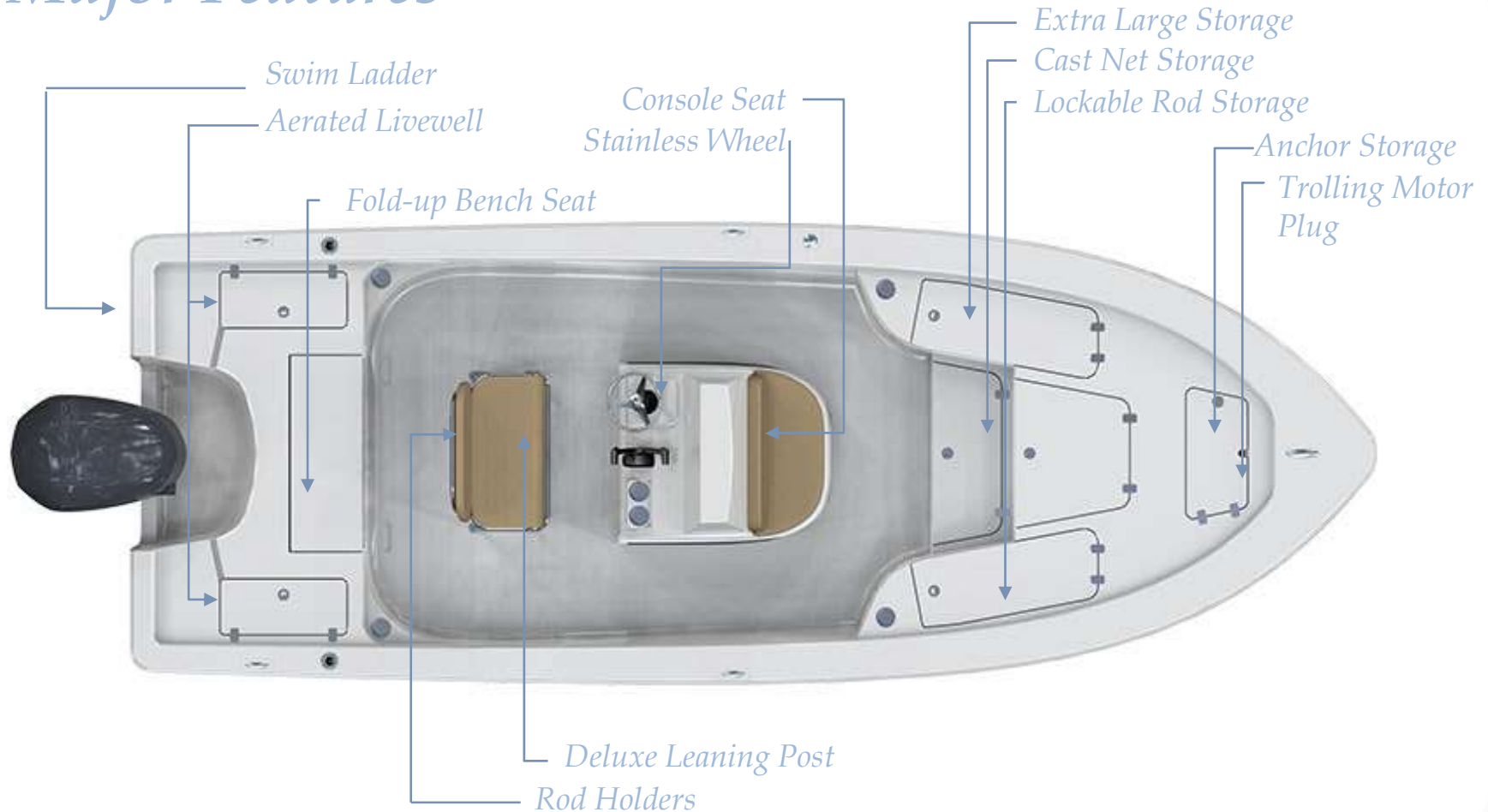

SPORTSMAN



NMMA Certification

Sportsman Boats is certified by the National Marine Manufacturers Association (NMMA). NMMA certification not only meets the standards of the United States Coast Guard (USCG), but goes further to meet the standards set by the ABYC (American Boat and Yacht Counsel). All Sportsman models have been designed, constructed, and thoroughly tested to meet or exceed these standards. For more information about these standards, you may visit <http://www.nmma.org/certification/boats>.

Hull Identification Number & Registration

Sportsman has a permanent record of your boat. This record is documented during the manufacturing process. It is identified by its "Hull Identification Number" (HIN). **The HIN is a 12-digit code located on the starboard side of the transom, just under the Rub Rail.** When contacting your dealer concerning maintenance or warranties, please have your HIN and model number available. This information can be found on your copy of the warranty card. Federal and State laws require a power boat to be registered in the state where it is primarily used. Registration numbers and validation stickers must be displayed according to regulations. The registration certificate must be on board when boating. The boat serial number, or Hull Identification Number (HIN), is required on the registration form. The HIN should be included on all documents or any correspondence.

Boating Safety



LIGHTING

Your Sportsman boat is equipped with navigation lights which comply with both Inland and International rules.

FIRE EXTINGUISHER

At least one Type-1 hand held portable fire extinguisher must be carried on board. For boats over 20' two are required. Check extinguisher regularly for charge status.

REQUIRED SAFETY EQUIPMENT

The US Coast Guard (USCG) requires that every boat have specific equipment on board. Check with local regulations on mandatory equipment apart from the list of Coast Guard requirements.

SOUND SIGNALING DEVICES

Your Sportsman boat is equipped with an electric horn which meets the USCG requirements for a sound signal device.

PERSONAL FLOTATION DEVICE (PFD)

You must have a USCG approved personal flotation device of Type I, II, or III aboard for each passenger, in addition to one Type IV throw able PFD. **Always wear a PFD when boating.** In some states, children are required to wear a PFD at all times. Check your local regulations.



VISUAL DISTRESS SIGNALS

USCG approved visual distress signals are required for day and night use when operating on US waters. Approved signals include flares, orange smoke, an orange distress flag, or an electric distress light.



Boating Safety



Being on the water is a great experience, but it can become a bad experience very quickly if safety and maintenance instructions of your boat are not followed. Therefore, warnings and notices have been included in order to help you operate and maintain your boat safely. They are defined as follows:

 **WARNING** 

HAZARDS OR UNSAFE PRACTICES WHICH COULD RESULT IN SEVERE PERSONAL INJURY OR DEATH.

 **DANGER** 

IMMEDIATE HAZARDS WHICH WILL RESULT IN SEVERE PERSONAL INJURY OR DEATH.

Please become familiar with the location and content of the Caution, Warning, and Danger Labels found on your boat.

Boating Safety



Your Owner's Manual was written to include safety instructions to ensure safe operations. Safety alert symbols are used to show potential personal injury hazards.

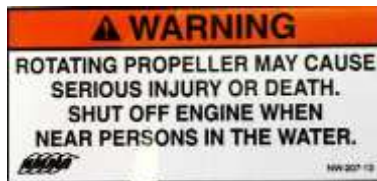

Every precaution has been taken to reduce the risks associated with death, possible injury and damage from fire or explosion. You must also take your own necessary precautions and practice proper maintenance procedures in order to enjoy the optimal safe operation of your boat.

If your label is damaged. Please call Sportsman's parts department for replacement stickers.

Boating Safety



Your boat produces carbon monoxide and uses flammable fuel. Carbon monoxide can cause brain damage or death. Carbon monoxide is colorless, odorless and extremely dangerous.

⚠ DANGER



Carbon monoxide (CO) can cause brain damage or death.
Engine and generator exhaust contains odorless and colorless carbon monoxide gas.
Carbon monoxide will be around the back of the boat when engines or generators are running.
Move to fresh air, if you feel nausea, headache, dizziness, or drowsiness.

NW-206-13

⚠ WARNING

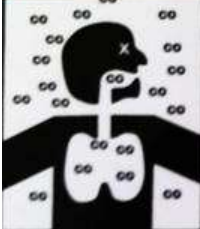

Carbon monoxide (CO) can cause brain damage or death.
Engine and generator exhaust contains odorless and colorless carbon monoxide gas.
Signs of carbon monoxide poisoning include nausea, headache, dizziness, drowsiness and lack of consciousness.
Get fresh air if anyone shows signs of carbon monoxide poisoning.
See Owner's Manual for information regarding carbon monoxide poisoning.

Boating Safety Label Locations



**MEETS U.S. EPA EVAP
STANDARDS USING
CERTIFIED COMPONENTS**

Sportsman Boats Mfg. Summerville, SC

MAXIMUM CAPACITIES
10 PERSONS OR 1800LBS.
3000 LBS. PERSONS, MOTOR, GEAR
 300 H.P. MOTOR

THIS BOAT COMPLIES WITH U.S. COAST GUARD SAFETY
 STANDARDS IN EFFECT ON THE DATE OF CERTIFICATION
 MEETS U.S. EPA EVAP STANDARDS USING CERTIFIED COMPONENTS
 MANUFACTURED BY Sportsman Boats Manufacturing, Inc.
 MODEL: Masters 247 Summerville, SC

BOAT COMPLIANT WITH NFPA REQUIREMENTS AS PERFORMED
 MANUFACTURED IN ACCORDANCE WITH THE U.S. COAST GUARD SAFETY
 STANDARDS IN EFFECT ON THE DATE OF CERTIFICATION

⚠ WARNING
 ROTATING PROPELLER MAY CAUSE
 SERIOUS INJURY OR DEATH.
 DO NOT APPROACH OR USE
 LADDER WHEN ENGINE IS RUNNING.

⚠ DANGER
Carbon monoxide (CO) can cause brain damage or death.
 Engine and generator exhaust contains odorless and colorless carbon monoxide gas.
 Carbon monoxide will be around the back of the boat when engines or generators are running.
 Move to fresh air, if you feel nausea, headache, dizziness, or drowsiness.

⚠ WARNING
Carbon monoxide (CO) can cause brain damage or death.
 Engine and generator exhaust contains odorless and colorless carbon monoxide gas.
 Signs of carbon monoxide poisoning include nausea, headache, dizziness, drowsiness and lack of consciousness.
 Get fresh air if anyone shows signs of carbon monoxide poisoning.
 See Owner's Manual for information regarding carbon monoxide poisoning.

⚠ WARNING
 CONTENTS CAN BE UNDER PRESSURE
 AVOID SERIOUS INJURY OR DEATH FROM
 FIRE OR EXPLOSION
 OPEN SLOWLY IN WELL VENTILATED AREA
 NO SMOKING OR OPEN FLAMES

⚠ WARNING
 AVOID SERIOUS INJURY OR DEATH
 FROM FIRE OR EXPLOSION
 RESULTING FROM LEAKING FUEL.
 INSPECT SYSTEM FOR LEAKS AT
 LEAST ONCE A YEAR.

⚠ WARNING
 ROTATING PROPELLER MAY CAUSE
 SERIOUS INJURY OR DEATH.
 SHUT OFF ENGINE WHEN
 NEAR PERSONS IN THE WATER.



SPORTSMAN

Boating Safety



The Sportsman Masters 247 has a 10 Person Capacity. Seating locations are shown below.

For your safety, casting deck is not to be used while boat is in motion.



MAXIMUM CAPACITIES

10 PERSONS OR 1800LBS.

3690 LBS. PERSONS, MOTOR, GEAR
300 H.P. MOTOR

THIS BOAT COMPLIES WITH U.S. COAST GUARD SAFETY STANDARDS IN EFFECT ON THE DATE OF CERTIFICATION

MEETS U.S. EPA EVAP STANDARDS USING CERTIFIED COMPONENTS

MANUFACTURER: Sportsman Boats Manufacturing, Inc.

MODEL: Masters 247 Summersite, SC

DESIGN COMPLIANCE WITH NMMA REQUIREMENTS IS VERIFIED.
MANUFACTURER RESPONSIBLE FOR PRODUCTION CONTROL.



NATIONAL MARINE MANUFACTURERS ASSOCIATION

SPORTSMAN

Electrical & Plumbing Systems

Wire Harness

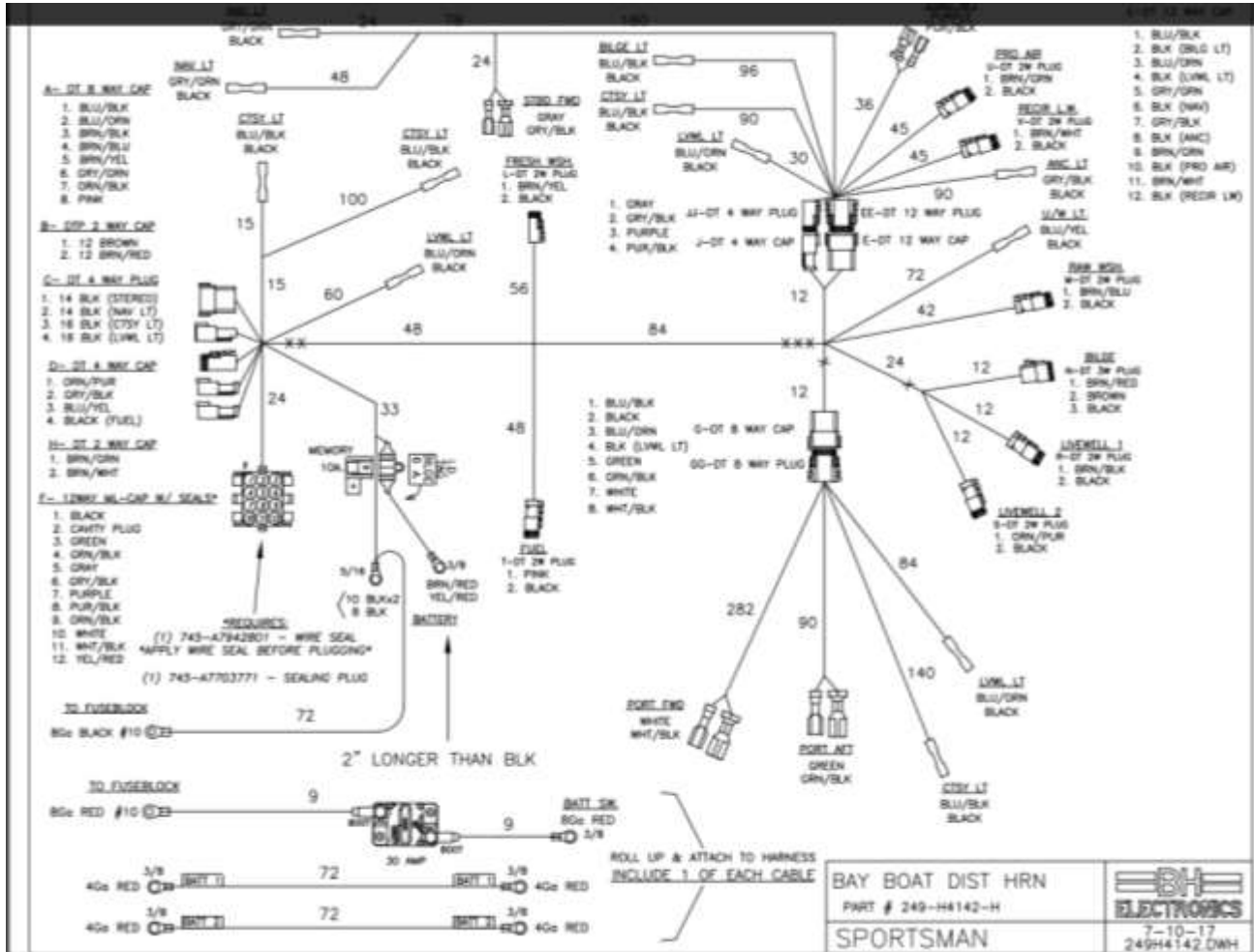

The fuse panel is located under the console. It is clearly labeled for easy identification. The bilge pump's 6 amp fuse is also located here. There is also a 30 amp breaker branching off the main battery switch. If an electrical component of your boat stops working properly, this should be the first place to look.



Electrical & Plumbing Systems

Garmin 12" Package

Sportsman offers the Garmin 1242xs multi-function Display which integrates the following functions with ease:

- ClearVü
- SideVü
- Stereo
- Sonar
- Radar Capability
- Navigation
- Engine Instruments
- Coastal Charts

SPORTSMAN

Electrical & Plumbing Systems

Garmin 12" Package

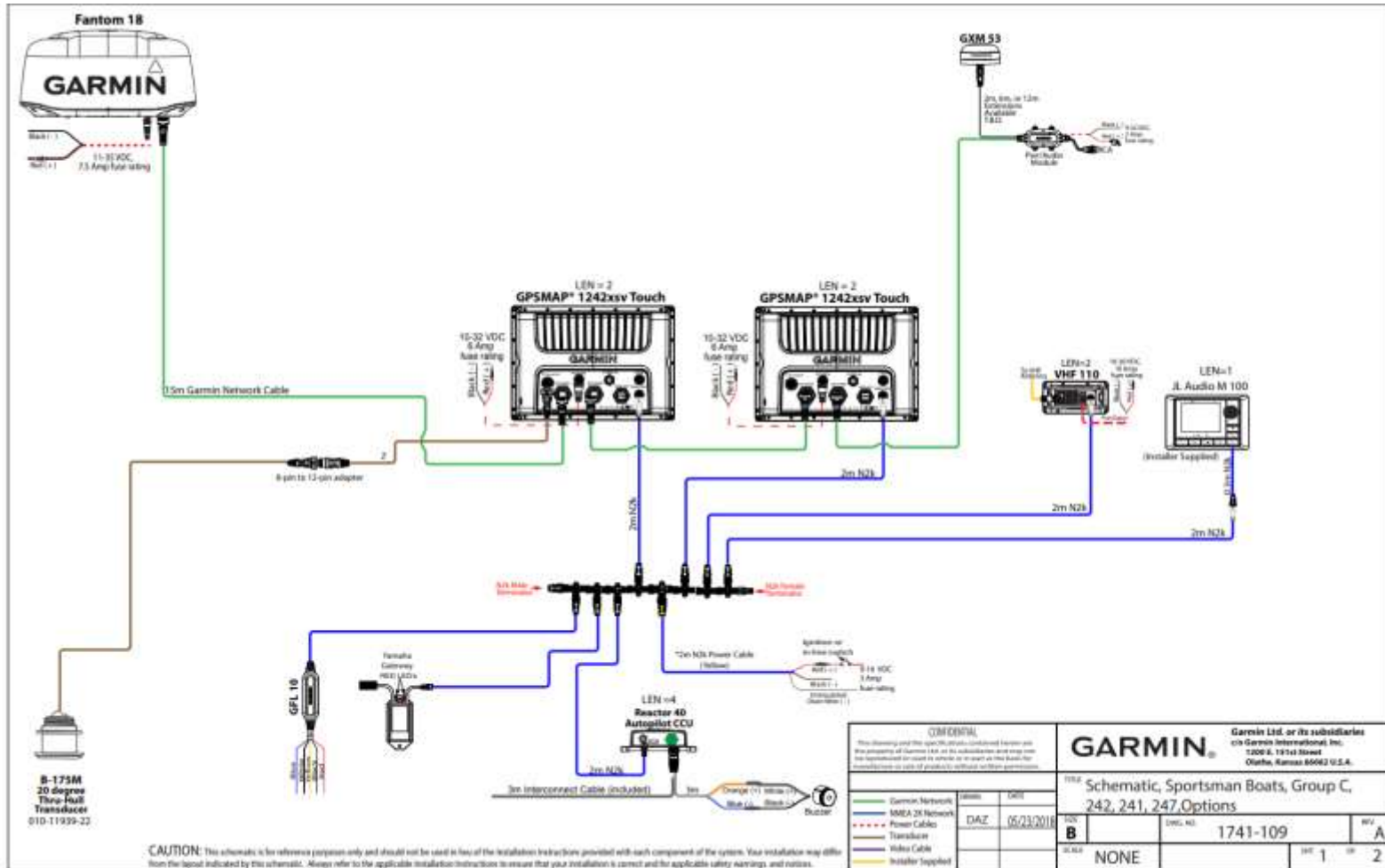

CONFIDENTIAL		GARMIN		Garmin Ltd. or its subsidiaries c/o Garmin International, Inc. 1200 S. 191st Street Olathe, Kansas 66062 U.S.A.	
TITLE Schematic, Sportsman Boats, Group C, 242, 241, 247 Options					
REV	DATE	ISS	ENGR. NO.	REV	
B	05/23/2018		1741-109	A	
SCALE	NONE		1	2	

Electrical & Plumbing Systems

Lights

The *NAV/ANC Switch* is a 3-position switch on the console that controls the running lights.

- **NAV** position will turn on the red and green navigation lights and the white all-round light for night driving.
- **ANC** turns on the all-round light only for night anchoring. Do not operate the boat in anchor position.
- Off is in the center position.

Sidelights: The Masters 247 has integrated rub rail navigational lights installed at the bow (see figure to the right). A green light is located on the starboard (right) side and a red light on the port (left) side of the vessel. Each shows an unbroken light over an arc of the horizon of 112.5 degrees and is fixed to show from ahead to just behind the beams of the vessel on its respective side.

All-round/Anchor Light: This is a white light placed over the highest unobstructed point of the vessel, showing an unbroken light over an arc of the horizon of 225° and fixed to show from anywhere ahead, to just behind the beams of the vessel. See the figure to the right for location.

Recreational boats are required to display navigation lights between sunset and sunrise and other periods of reduced visibility (fog, rain, haze, etc.) Navigation lights are intended to keep other vessels informed of your presence and course. Your boat is equipped with the navigation lights required by the U.S. Coast Guard at the time of manufacture. It is up to you to make sure they are visible, operational and turned on.



Bow Sidelights

If you have the underwater lights option installed, they can be turned on with the switch at the helm labeled "Accessory 1."

If your boat has a T-top, the anchor light is located on top of the T-top at the aft end. With no T-top, the location is at the stern of the boat as shown here.

Anchor Light if no T-Top



Electrical & Plumbing Systems



Stereo

With the upgrade your boat is equipped with a JL Audio MM50 Stereo and 4 MX Speakers. The stereo is water resistant and built to withstand all elements. It gives an intuitive interface with an easy to read 2.8 inch LCD display with day and night functions.

Your boat has a Fiberglass T-Top, is standard with 4 speakers. These four speakers will be located on the T-Top underside fore and aft.



Speakers

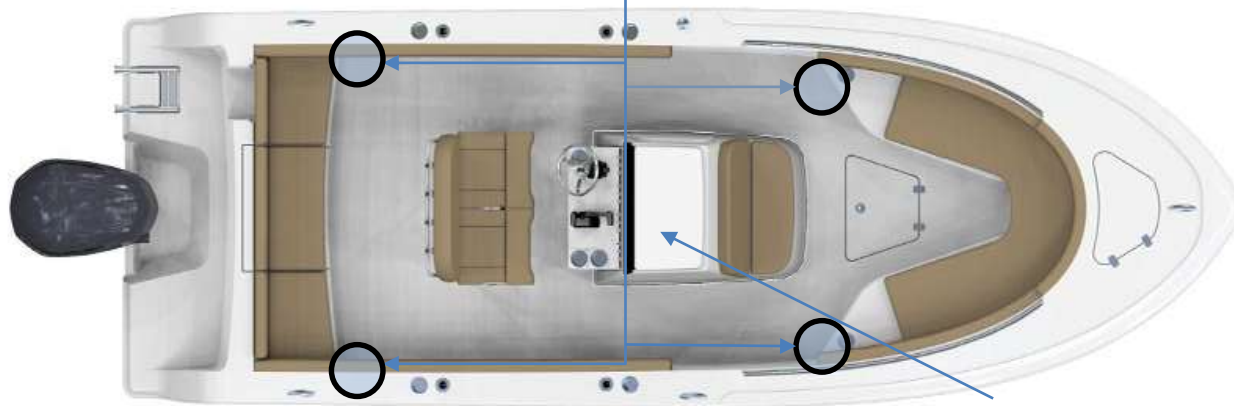

Infinity Box

If you purchased the JL stereo upgrade option, this comes with 8 JL speakers, a four channel amplifier for your pair of 8" subwoofers. Also 8 channel amp to power your speakers

SPORTSMAN

Electrical & Plumbing Systems

Stereo

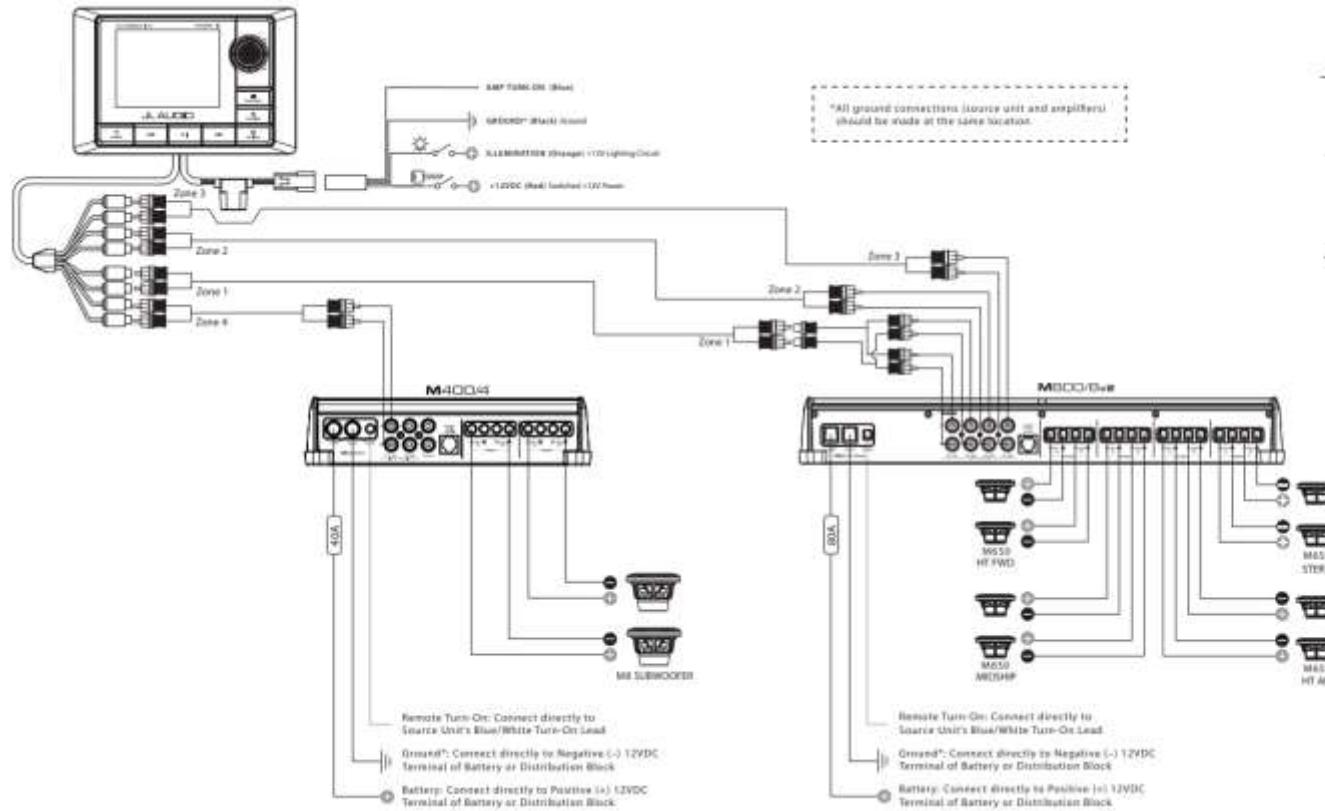

JL AUDIO
 MARINE

SPORTSMAN
 2019
 Heritage 241 Center Console
 Open 242 Center Console
 Masters 247 Bay Boats
 AUDIO SYSTEM WIRING DIAGRAM



Electrical & Plumbing Systems

Stereo



The Masters 247 **Premium Stereo** is equipped with a M800/8v2 (8 channel Amplifier). This incredibly flexible amplifier packs a serious full-range punch and delivers a staggering 100 watts to each of its eight channels into 2 ohms (28.8V, 1% THD). The breakthrough that makes this much power possible in such a small chassis is our NexD™ ultra-high-speed switching design, which allows for full bandwidth Class D operation with extremely low distortion and outstanding efficiency.

This boat is also equipped with an M400/4, this tiny amplifier packs a serious full-range punch, delivering a staggering 100 watts to each of its four channels into 2 Ω (14.4V, 1% THD). The breakthrough that makes this much power possible in such a small chassis is our NexD™ ultra-high-speed switching design, which allows for full bandwidth Class D operation with extremely low distortion and outstanding efficiency.

SPORTSMAN

Electrical & Plumbing Systems

Trim Tabs Option

Your Masters 247 may have the trim tabs installed as an option. If so, they will be attached to the bottom edge of the transom, as shown in the image below. When the trim tabs control at the helm (pictured to the right) is pressed, the trim tabs automatically move into position. The force of passing water on these tabs results in upward pressure at the transom, which will lower the bow. This helps to improve the performance of the boat in a wide range of weight, weather, and water conditions.

The LEDs on the control panel indicate the position of the tabs. If all are lit up, that tab is all the way down. The port and starboard tabs may be operated independently if necessary. To lower the starboard bow, lower the port tab. To lower the port bow, lower the starboard tab. The lights on the left indicate the port tab position, and the lights on the right indicate the starboard tab position.



Control Panel



Trim Tabs

SPORTSMAN

Electrical & Plumbing Systems



Trim Tabs Option

*If you keep your boat in a wet slip/marina environment.
Here is a list of different anodes recommended for various water
types to prolong the life and shine of your stainless steel tab.
Never use a wire brush to clean your tab!*

Zinc Alloy Anodes = Salt water only

Not recommended for use in fresh water

Alloy is manufactured to meet or exceed US Military Specification (MIL-A-18001K)

Aluminum Alloy Anodes = Salt or Brackish water

Not recommended for use in fresh water

Proven to last longer than zinc due to increased capacity

Alloy is manufactured to meet or exceed US Military Specification (MIL-A-24779(SH))

Magnesium Alloy Anodes = Fresh water only

Not recommended for use in salt or brackish water



Trim Tabs

SPORTSMAN

Electrical & Plumbing Systems

Bilge Pump

A small bilge pump is located on the hull bottom at the stern of your boat. Water is pumped out of a thru-hull fitting located on the starboard side of the boat near the transom. The pump may be accessed by removing the aft seat and door, in the area shown to the right. You may turn your bilge pump on manually by flipping on your bilge switch located on the switch panel at the helm. Additionally, the bilge pump utilizes a float as an automated switch to turn it on automatically if necessary when the boat is unattended. The bilge pump is designed to remove excess water **only**, and it is **not** intended to stop or prevent rapid accumulation of on-board water due to rough weather, hull damage, or any other unsafe navigational conditions.

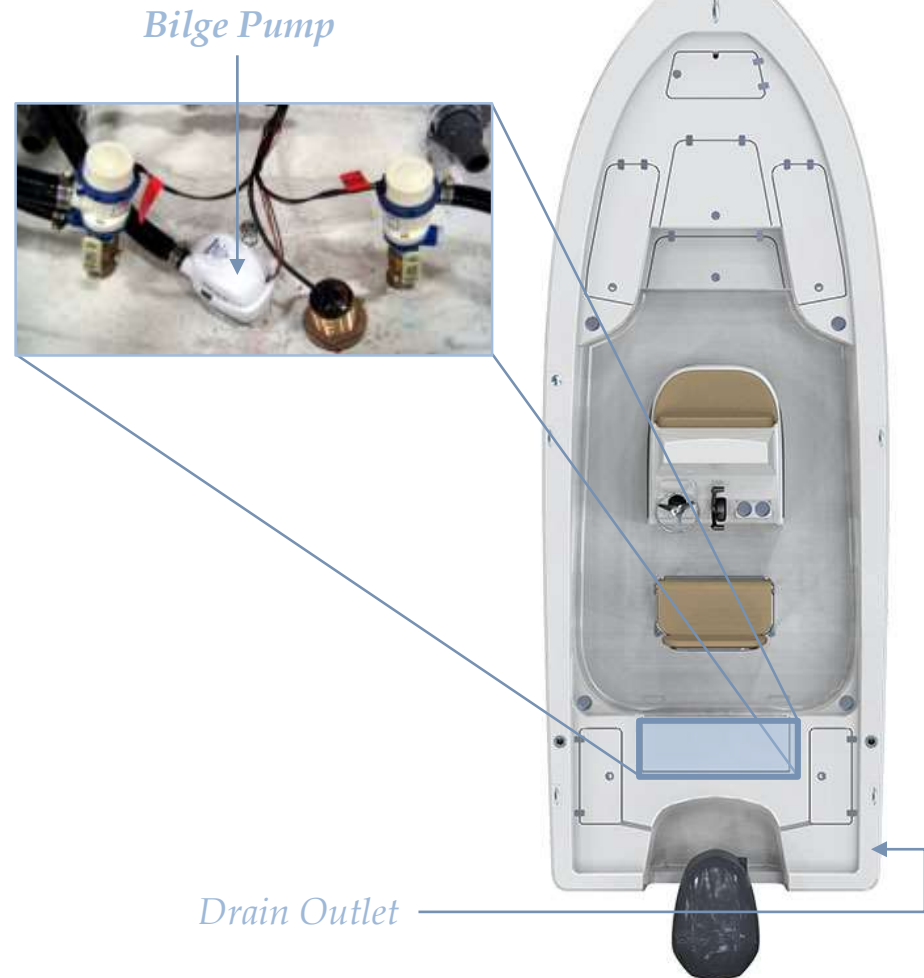

SPORTSMAN

Electrical & Plumbing Systems

Livewells

The Sportsman 247 comes with two 25 gallon livewells at the stern of the boat and one 12 gallon livewell under the front seat of the console. For easy access to the pumps and plumbing systems, open the total access hatch forward of the transom. The livewell pumps are located on either side of the bilge pump in the hull of the boat, and the livewell fill hoses are connected to the top of the pumps. To operate the livewells, turn on the livewell switch at the helm and turn the fill valve in the livewell to "open." To operate the starboard aft livewell and the console livewell, use the switch labeled "Livewell 1." To operate the port aft livewell, use the switch labeled "Livewell 2." All livewells are equipped with overflow drains so water cannot exceed a certain level and overflow. These overflow drains are connected to the main drain lines at 'T' joints, which empty out an outlet drain at the stern of the boat. Additionally, each livewell has LED lighting installed. To illuminate the livewells, turn on the switch at the helm.



Console Seat Livewell (with overflow, fill valve, and drain)



Rear Livewell



Fill Valve

Overflow Drain



Drain

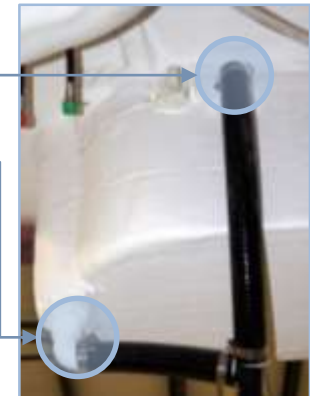

Pumps To Fill Valves

SPORTSMAN

Electrical & Plumbing Systems

Recirculating Aerated Livewell



Your Sportsman Masters 247 has a recirculating livewell as a standard feature. The starboard aft livewell is equipped with an aeration and recirculation system. The two black strips on the inside walls of the livewell are part of the aeration system. The air pump (mounted on the side of the livewell) pushes air through the air stone at the base of each strip, which produces air bubbles to oxygenate the water. This feature is best for keeping bait alive overnight or for use when the boat is not in use, because it draws very little power. The recirculation system features an intake (with a strainer cover, shown in the figure) and an outlet water jet. The jet is mounted in the corner of the livewell in order to allow for optimal water recirculation when in use. The recirculation pump is a white tsunami water pump mounted on the side of the livewell. This system is operated with a 3-way switch at the helm of the boat. The system is off

Note: The set-up in this figure is not exactly like the set-up in your boat. This is just a simple representation of the major features for this system. The exact mounting locations will be different in your boat than the locations shown here.

Air Pump

Air Stone

Recirculation Intake

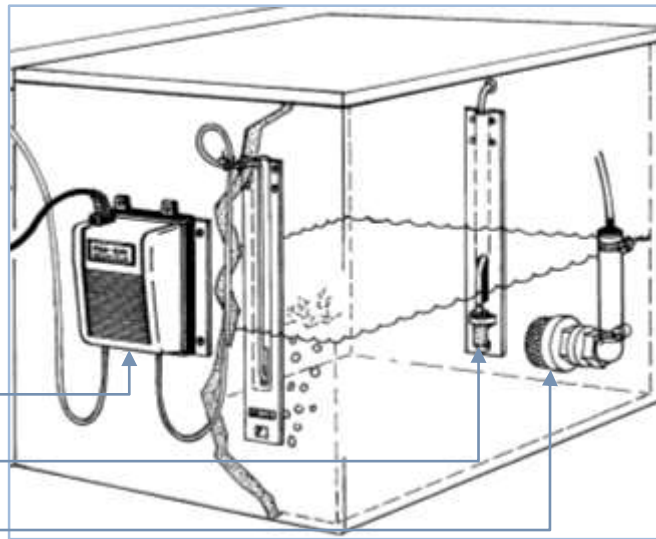

with the switch in the middle position. With the switch up, the aeration system alone will run, which draws very little power. With the switch down, the recirculation system will run. The figure here displays most of the important features of the recirculating livewell system.

Electrical & Plumbing Systems

Raw Water Wash-down

Your Masters 247 may have the raw water wash-down installed as an option. Rinsing your boat immediately after use with a powerful water jet helps to maintain the boat's condition and value. This system supplies water via a hose connected to bottom of the same pump that supplies water to your livewells with a shut off valve in the bilge area at the total access hatch. To operate the wash-down system, start by opening the valve mentioned above. Then turn on the switch labeled "WASHDOWN" on the switch panel at the helm. The wash-down outlet is found inside the small step storage compartment at the bow. See the figures here for important feature locations for the raw water wash-down system.

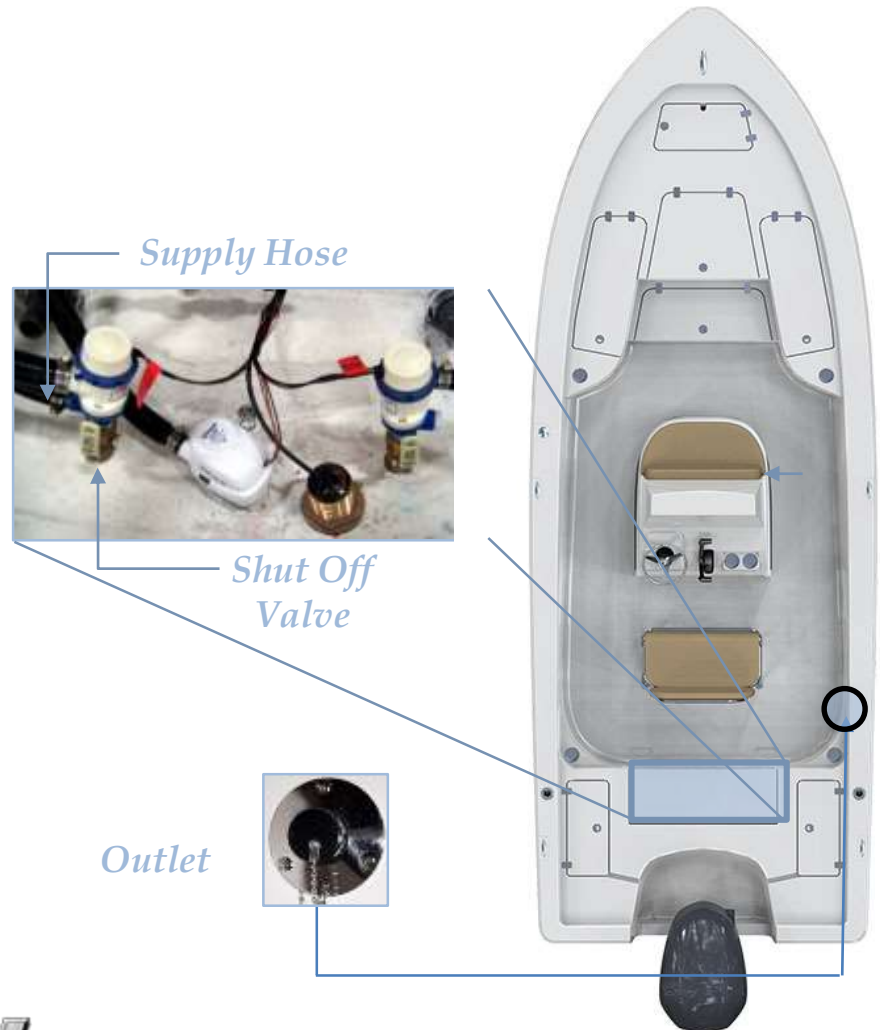

SPORTSMAN

Electrical & Plumbing Systems

Fresh Water Wash-down

Your Masters 247 may have the freshwater wash-down installed as an option. The freshwater fill fitting and Outlet is located inside the step storage compartment at the bow. This enclosed area is also a good place to store the hose. **Do not leave the tank full if your boat will be left unattended for an extended period of time;** pump the tank dry to avoid stagnant water in the tank if necessary. It is also important to periodically inspect and clean the filter, which is located on the pump. The pump is mounted on the inside of the console on the starboard side. To operate this system, turn on the switch labeled "ACCESSORY 2" at the helm. This will pressurize the system for use. When the tank is empty or the boat is not in use, ensure that this switch is in the off position.

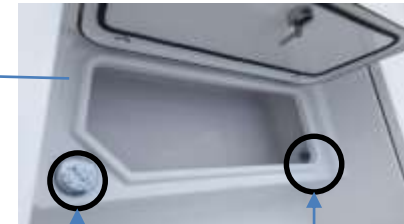

Fill

Outlet

SPORTSMAN

Fuel System

Fuel Tank

The Sportsman Masters 247 comes with a fuel tank installed (71 approximate usable gallon capacity). The gasoline fuel system consists of a fuel tank (located underneath the helm seat as shown in the figure), anti-siphon valve, engine fuel supply line, and fill cap. Your boat contains a new EPA certified fuel system. The system prevents spit-back when filling the tanks and lowers the out gassing emissions through a vent in the new designed fuel fill cap.

Note: This photo was taken during the assembly process. At this stage, some of the hoses had not yet been connected. In your boat all lines and hoses will be connected as necessary.

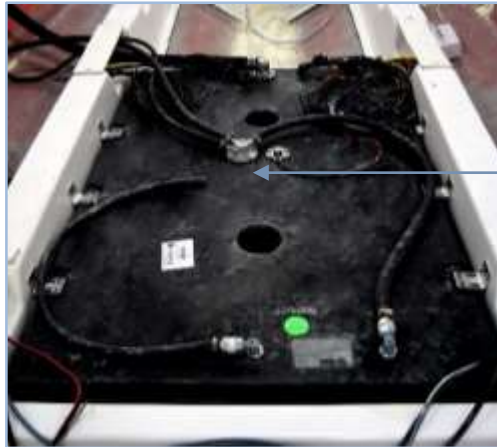

Fuel System

Diurnal Fuel System



BluSkies

EPA DIURNAL FUEL SYSTEMS

NOTE: Pressure may be present when opening your deck fill, regardless of system type.



Only open the fuel cap for refueling

Note: The first time fuel is introduced to a fuel tank, be aware of the interaction of cold raw fuel vapors replacing air, on occasion a vapor pressure can occur producing spit-back anomalies!

What is a diurnal fuel system?

Your new vessel is equipped with an Environmental Protection Agency (EPA) compliant diurnal fuel system, designed to reduce fuel emissions to atmosphere using criteria mandated by the EPA. Your vessel's fuel tank is required and designed to have a positive pressure (>1PSI) as the sun heats the boat and the fuel in the tank expands or it may be equipped with a carbon canister to catch and contain fuel vapors

Your boat's fuel tank also has valves installed inside that are designed to:

1. Produce a clean refueling shut off event
2. Create a 5% vapor space
3. Reduce the propensity of a refueling spit-back event.
4. Allow for appropriate venting when the vessel is stored or trailered. Your fuel cap also contains valves designed to retain fuel vapor (up to 1PSIG) and to allow make up air during engine operation

SPORTSMAN

Fuel System

Diurnal Fuel System (cont'd)

Vapor Space (Ullage) And Refueling Management

Another fuel system necessity to remain EPA compliant it is to keep elevated temperature gasoline from expanding into fuel system areas that are not low permeation rated or otherwise sensitive to raw fuel. A vapor (or ullage) space must be produced at the completion of the filling or refueling operation to ensure systems remain EPA compliant during the diurnal temperature cycle. To effectively manage this system function, BluSkies has created a series of valves that can mount to any marine fuel tank to achieve the appropriate fill level while maintaining ullage space of ~5%. Additionally these valves eliminate the propensity for refueling "spit-back" or tank "well-back", which is another requirement of the EPA regulation. BluSkies primary ullage valves replace the existing fill and vent locations, while additional grade or tip level valves can be added to any tank to meet American Boat And Yacht Council standards (H-24) which allows vapor venting for boats slanting or sloping when stored, moored, parked or trailered.

The final decision on which system type and ullage valve type and placement that is best for your application should be based on application specific factors such as type and configuration of fuel tank, how much room there on board is for added components, how are the boats likely to be used and stored etc. and of course cost.

Choose individual components to create a compliant system from the following pages or you can turn to our specialists for sound guidance and direction as you go through the process to choosing the appropriate system for your particular vessel application.

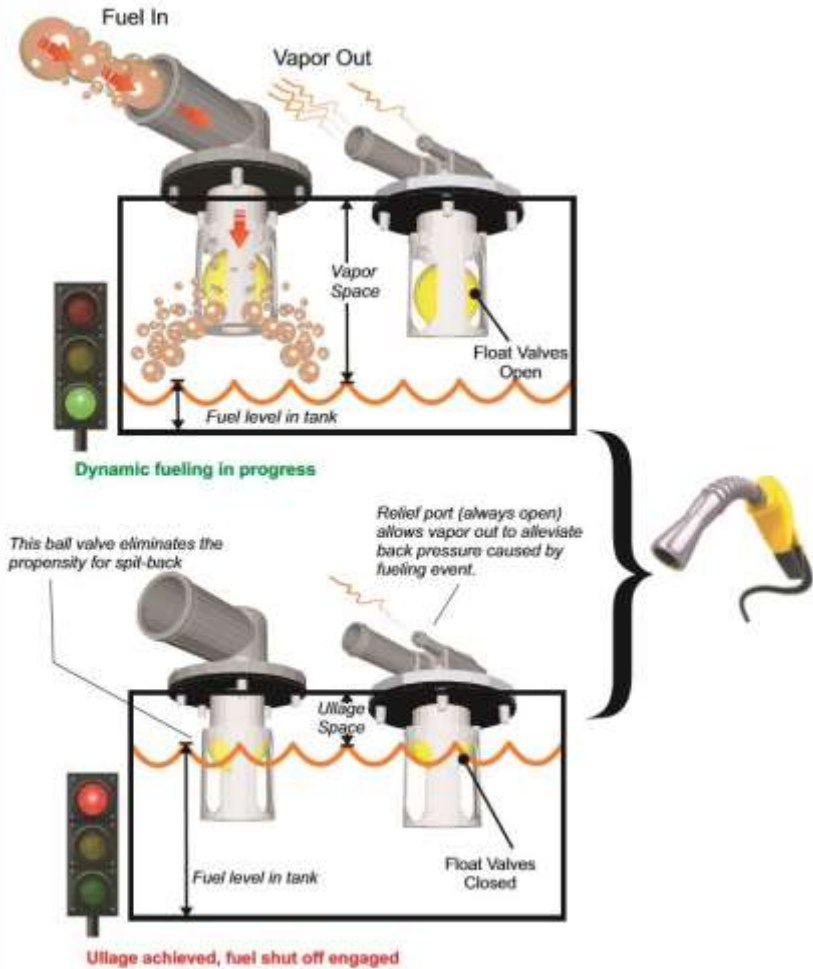

SPORTSMAN

Fuel System

Tank Vapor Space & Fluid Management



Ullage (Vapor Space) Level Attainment Spit-back/Well-back Control

This vent valve shuts off the refueling vapors and creates back pressure to lift the fill valve ball into place.

This fill valve ball is set lower than the vent valve ball but does not close until the refueling vapors are shut off by the vent valve.

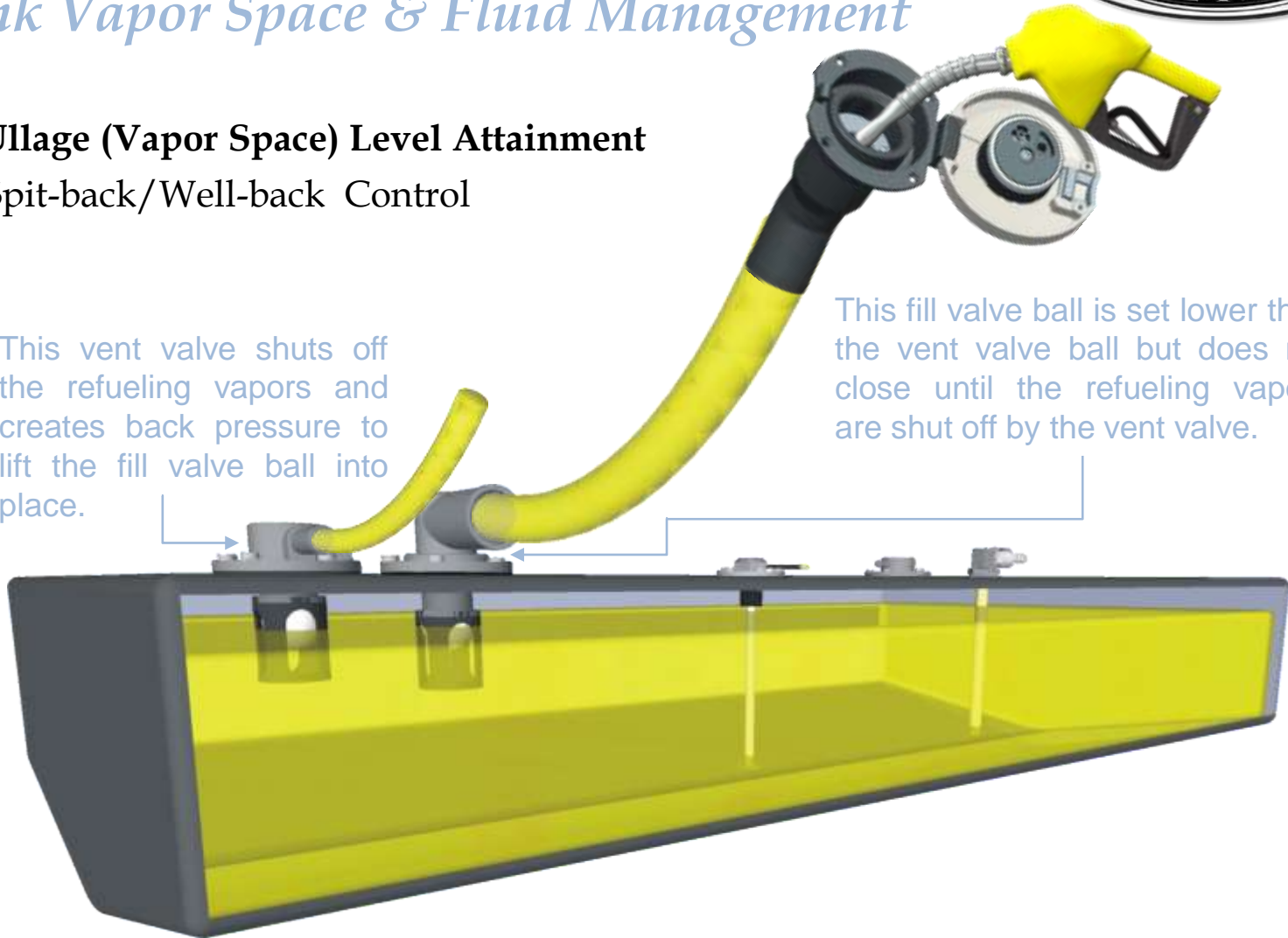

SPORTSMAN

Fuel System

Diurnal Fuel System: Refueling



Your fuel tank capacity will vary from the label or published capacity no less than 5% by law and up to 10% dependent upon the variation from static float due to equipment, occupants and gear etc. (Static Float = attitude in which your boat floats in calm water)

Fill your vessel fuel tank as normal, stop refueling after two (shut off) clicks of the fuel nozzle.

Topping off will over ride your fuel system design intent and could cause damage to your vessel due to overflow and will void any and all warranty claims related to fuel spillage.

BluSkies is expressly not responsible for any damage to your vessel subsequent to topping off.

WARNING

CONTENTS CAN BE UNDER PRESSURE
AVOID SERIOUS INJURY OR DEATH FROM
FIRE OR EXPLOSION
OPEN SLOWLY IN WELL VENTILATED AREA
NO SMOKING OR OPEN FLAMES

It has been a common practice for many years to top off boats prior to storage or in preparation for a day on the water, however diurnal fuel systems are designed specifically to leave a space in your fuel tank to allow the fuel to expand during the heat of the day. GASOLINE EXPANDS 5%.

REFUELING

GASOLINE CONTENTS UNDER PRESSURE. FUEL SPRAY MAY OCCUR.

1. OPEN CAP SLOWLY
2. INSERT FUEL NOZZLE
3. BEGIN & CONTINUE FUELING UNTIL FUEL NOZZLE KICKS OFF
4. WAIT 10 SECONDS & CONTINUE FUELING UNTIL NOZZLE KICKS OFF A SECOND TIME
5. RETURN NOZZLE TO PUMP
6. DO NOT TOP OFF

SPORTSMAN

Boating Navigation Rules



There are three main situations that you may encounter with other vessels which could lead to a collision unless the Steering Rules are followed:

- Meeting**: you are approaching another vessel head-on
- Crossing**: you are travelling across the path of another vessel
- Overtaking**: you are passing or being passed by another vessel

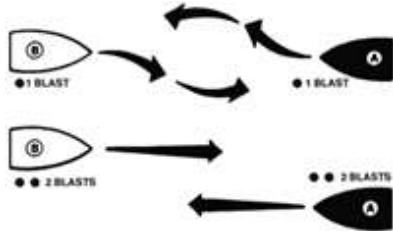

When Meeting Port-to-port: Continue on course. The same holds true for meeting starboard-to-starboard.

When Meeting Head On: As in a car, both stay to your right and as far apart as practical. Each boat should turn to starboard and pass port-to-port.

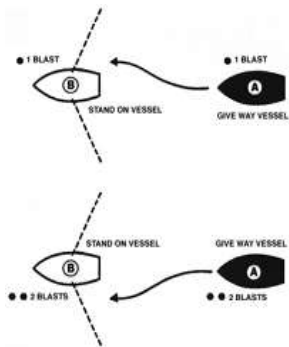

When Crossing: Every boat has a "Danger Zone" from straight in front (the bow) to past the middle of its right side. Like when meeting another car at a street intersection, the one on the right has the right of way. You must yield to boats in your Danger Zone. If you are the skipper of the Vessel A in the center of the diagram, you must keep out of the way of any boat that approaches you from any direction within the indicated Danger Zone, as you are the burdened craft. Likewise, boats approaching you from all other directions, except the meeting vessel, must keep clear of you.

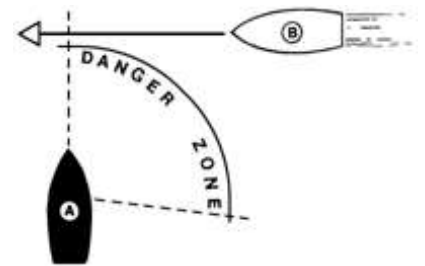

When Overtaking Another Boat: The boat being overtaken is the privileged vessel. Only after signaling and receiving an acknowledgment can the overtaking boat pass. (Use one blast to pass on the right, and two blasts to pass on the left.)

When Being Overtaken: Be ready for trouble when a power boat passes you in a narrow waterway. As the lead boat, which always has the right of way, stay on your side of the channel and maintain a steady speed so that the overtaking vessel can pass you safely. Use your radio to discuss this with the passing boat.

Warranty and Services



Product Changes

Sportsman is committed the development of our product line. As a result, equipment described in this manual may have changed or no longer may be available. All information, illustrations and specifications contained in this manual reflect the latest product information available at the time of publication. Sportsman reserves the right to make changes to its boats at any time, without notice. These changes include, but are not limited to: color options, materials, standard and optional equipment, specifications and model availability. If you have any questions about the equipment on your boat, please feel free to contact Sportsman.

Insurance

In most states, the boat owner is legally responsible for damages or injuries they or anyone else operating the boat causes. Some states have laws that require having at least minimum coverage. Before using your boat for the first time, you should contact your dealer, current insurance company, or state boating authority for information regarding insurance requirements in your area. Although it may not be required in your area, responsible boat owners carry liability and property damage for their boat. You should also protect the boat against physical damage and theft.

Service

All warranty work must be performed by an authorized Sportsman Dealer. If a problem is discovered upon taking delivery of, or develops during routine use of the boat that is related to faulty workmanship and/or materials, as stated in the warranty, you need to contact your Sportsman dealer to arrange for your boat to be repaired. **The boat owner is responsible for delivering the boat to the dealer for warranty service.** If you are not near your dealer or any other authorized Sportsman dealer, please contact Sportsman. Likewise, if the dealer fails to repair the problem, please notify Sportsman within 14 days of the work being completed. **Sportsman will not reimburse owners for unauthorized warranty work.**

Warranty and Services



SPORTSMAN BOATS LIMITED WARRANTY

Ten-Year Hull Limited Warranty: This limited Warranty applies to any Structural Hull Defect (as that term is defined below) if such is due to a failure in material or workmanship and the was reported to Sportsman according to the terms of this Limited Warranty within ten (10) years from the date of the sale to the original purchaser of the Sportsman authorized dealer. Sportsman, in its sole discretion, will either repair or replace the Hull. For purposes of this Limited Warranty, the term “Hull” shall mean the single fiberglass molded shell and integral structural components of a Sportsman Boat, and the term “Structural Hull Defect” shall mean a substantial defect in the Sports Boat’s Hull that causes the boat to be unfit or unsafe for general use as a pleasure craft under normal operating conditions.

One Year Nonstructural Limited Warranty: This Limited Warranty applies to any Nonstructural Defect (as that term is defined below) if such is due to a failure in material or workmanship and the same was reported to Sportsman according to the terms of this Limited Warranty within one (1) year from the date of the sale to the original purchaser of the Sportsman Boat by a Sportsman authorized dealer. Sportsman, in its sole discretion, will either repair or replace the defective component. For purpose of this Limited Warranty, the term “Nonstructural Defect” shall mean a substantial defect in a Sportsman Boat’s components manufactured or installed by Sportsman (other than the Hull) that is not excluded in the exclusions below.

Registration and Transfer of Limited Warranty: Each original purchaser of a Sportsman Boat shall complete and return the boat registration card provided by Sportsman within thirty (30) days of such owner’s purchase of the boat in order to facilitate the processing of warranty claims and for manufacture notification. Except where a Sportsman Boats has been salvaged and resold after a declaration of a total loss or a total loss or a constructive total loss, this Limited Warranty is transferrable to a subsequent owner of the Sportsman Boat. PROVIDED SUCH SUBSEQUENT OWNER FILL OUT AND SEND TO SPORTSMAN A SPORTSMAN WARRANTY TRANSFER FORM (AVAILABLE FROM SPORTSMAN ON REQUEST). A COPY OF THE BILL OF SALE, WHITHIN THIRTY (30) DAYS OF SUCH TRANSFER OR PURCHASE.

Warranty and Services



SPORTSMAN BOATS LIMITED WARRANTY (cont'd)

EXCLUSIONS:

This limited Warranty does not apply to any boat that has been salvaged or declared a total loss or constructive total loss for any reason not specifically covered in this Limited Warranty. In addition, this Limited Warranty does not apply to the following "Exclusions:"

- 1) A Hull, component, or other product that has been repaired without authorization of Sportsman or that has been altered in any way that affects its use and operation;
- 2) Expenses related to inspection or warranty service for hauling out, transportation to and from any dealer or Sportsman factory, towing or storage changes, inconvenience or loss of time or income;
- 3) Engines, outdrives, controls, propellers, engine brackets, stereos, depth finder, GPS units, trolling motors, batteries, outriggers bases' and other equipment or accessories that are not manufactured by Sportsman, whether the same is or is not warranted by such other manufacturer;
- 4) Blistering, discoloring, cracking, or crazing of the Gelcoat finish or other surface finishes
- 5) Any Sportsman Boat initially sold at retail by a party other than an authorized Sportsman dealer;
- 6) Damage to, breakage of, or leakage around any windshields, hatches, or apertures;
- 7) Any canvas, zippers, vinyl, upholstery, plastic, or fabric components;
- 8) Discoloration, oxidation, bleeding, or corrosion of any stainless steel or other metal products
- 9) Any Hull, component, or product that has been subject to unreasonable use, tampering, abuse, mishandling, improper maintenance, negligence, improper trailing, alterations, or accidents;
- 10) Any boat, or component or part thereof, that has been used for Commercial Purpose, racing purposes, or has otherwise been operated contrary to any printed instruction provided by Sportsman or contrary to any applicable law (for purposes of this Limited Warranty, the term "**Commercial Purposes**" shall mean the usage of any boat more than fifty percent (50%) for revenue-producing or other business purposes);
- 11) A boat, or component or part thereof, that has been overpowered according to the maximum recommended engine horsepower specified on the capacity plate attached to the boat;
- 12) Machinery, equipment and accessories not installed by Sportsman;
- 13) Condensation of gauges;
- 14) The failure of any part, area, or component of the boat to be dry, whether or not the same was represented as "dry";
- 15) Any representation relating to the speed or weight of any part or component of the boat;
- 16) Normal wear and tear maintenance items, including, but not limited to, filters bulbs, batteries, bungees, anchor rope, trailer finishes, tires, brakes, bearing, and lights;
- 17) Any defect or repair requiring redesign of the boat, except pursuant to the recall provisions of the United States Federal Boat Safety Act of 1971 or the recall laws of the recall laws of any other foreign jurisdiction;
- 18) Dealer preparation, cleaning, and final adjustments and alignments in preparing the boat for delivery or commissioning; or
- 19) Any act of God or force majeure.

SPORTSMAN

Thank you for your purchase of your Sportsman Boat.

Sportsman Boats Manufacturing, Inc.
113 Isaac Way · Summerville, South Carolina 29483
Telephone (843) 376-2628 · Fax (843) 376-2636

Email
sales@sportsmanboatsmfg.com

Website
www.sportsmanboatsmfg.com

P.O. Box 2100
Summerville, SC 29484



SPORTSMAN